

UN06B05

UMTS Band 5/18/19/20/26 CDMA2000 BC0/BC10 sub2-3
Power Amplifier IC (814MHz to 862MHz)

Applications

- WCDMA handset
- HSDPA
- HSUPA
- LTE
- CDMA2000
- EVDO

Type

- Hybrid Integrated Circuit

Features

- High efficiency operation
46% @ 28.5dBm
- Small, low profile LGA package
3mm x 3mm x 0.85mm (1mm Max)
- Low Voltage Positive Bias Supply
(3.2V to 4.35V)
- 2-Mode Power States with Digital Control Interface
- Optimized for DC/DC converter operation
- Integrated Power Coupler
- Integrated Blocking capacitors

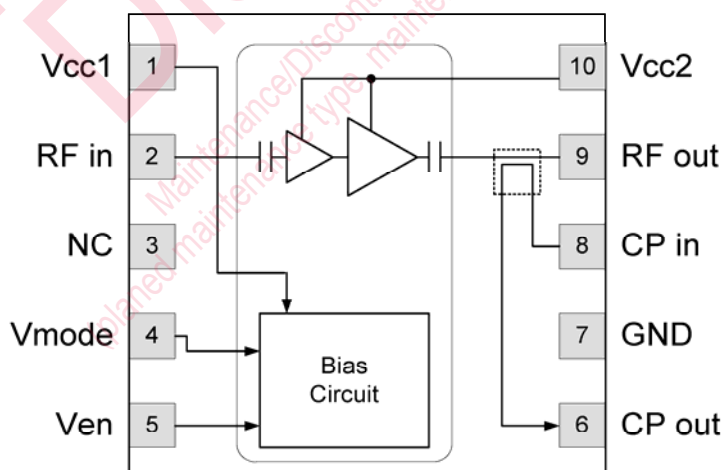

Pin Assignment

Pin No.	Pin Name
1	Vcc1
2	RF in
3	NC
4	Vmode
5	Ven
6	CP out
7	GND
8	CP in
9	RF out
10	Vcc2
11	GND

TOP VIEW

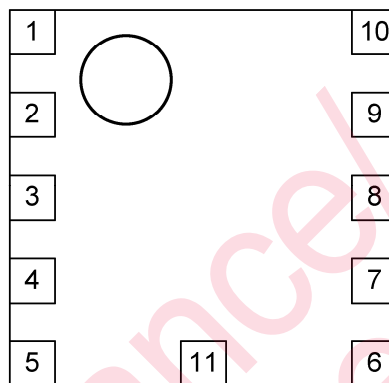

Note: Pin No. 11 shows the central terminal at the bottom package.

Recommended Circuit

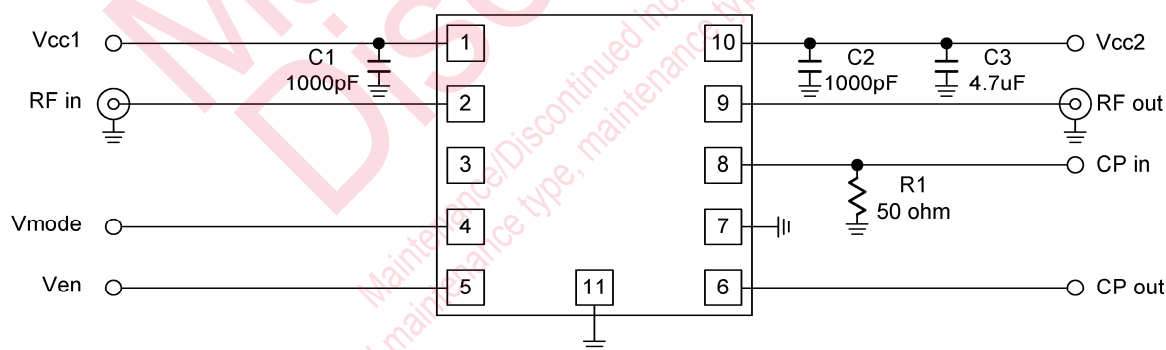

C1: 1000pF to 0.1uF (Set up C1 from the terminal Vcc1 to the distance within 1mm.)

C2: 1000pF to 0.1uF (Set up C2 from the terminal Vcc2 to the distance within 1mm.)

C3: 1uF to 4.7uF (Set up C3 from the terminal Vcc2 to the distance within 30mm.)

R1: 50 ohm



■ Absolute Maximum Ratings

Parameter	Symbol	Rating	Unit	Notes
Supply voltage	Vcc1,2	6	V	1,2
Control voltage	Ven, Vmode	4.2	V	1
Input RF power	Pin	10	dBm	1,3
Storage temperature	Tstg	-35 to +150	°C	1

■ Operating Ranges

Parameter	Condition	Symbol	Min	Typ	Max	Unit	Notes
Operating Frequency		f	814		862	MHz	
Supply Voltage 1		Vcc1	3.2	3.4	4.35	V	
Supply Voltage 2		Vcc2	0.4	3.4	4.35	V	
Enable Voltage	Low	Ven	0		0.5	V	
	High		1.35	1.8	3.1		
Mode Control Voltage	Low	Vmode	0		0.5	V	
	High		1.35	1.8	3.1		
Ambient Temperature	UMTS / LTE	Ta	-30		85	°C	
	CDMA		-30		85		

■ Modes of operation

Parameter	Ven	Vmode	Pmax			
			Rel99	HSPA	LTE	CDMA
High-power mode (HPM)	High	Low	≤ 28.5	≤ 27.25	≤ 27.25	≤ 27.5
Low-power mode (LPM)	High	High	≤ 15	≤ 14	≤ 14	≤ 14
Shut down mode	Low	Low	-	-	-	-



■ Electrical performance-1

Vcc1=3.4V, Ven=1.8V, Ta=+25 °C, ZS=ZL=50 ohm

f=814 to 862MHz

Signal Condition: Rel99 Pmax: refer to Page 4

Parameter	Symbol	Condition	Min	Typ	Max	Unit	Notes
Gain	G	HPM, Pout=28.5dBm, Vcc2=3.4V LPM, Pout=15dBm, Vcc2=1.1V	25.0 14.0	28.5 18.0		dB	
Total Supply Current	Ict	HPM, Pout=28.5dBm, Vcc2=3.4V LPM, Pout=15dBm, Vcc2=1.1V LPM, Pout=-30dBm, Vcc2=0.4V		456 100 30	530 125 40	mA	
Power Added Efficiency	PAE	HPM, Pout=28.5dBm, Vcc2=3.4V LPM, Pout=15dBm, Vcc2=1.1V	39 22	46 28		%	
Adjacent channel leakage power ratio1	ACLR1	5MHz offset HPM, Pout=28.5dBm, Vcc2=3.4V LPM, Pout=15dBm, Vcc2=1.1V LPM, Pout=-30dBm, Vcc2=0.4V		-41	-36	dBc	4
Adjacent channel leakage power ratio2	ACLR2	10MHz offset HPM, Pout=28.5dBm, Vcc2=3.4V LPM, Pout=15dBm, Vcc2=1.1V LPM, Pout=-30dBm, Vcc2=0.4V		-56	-46	dBc	4
Quiescent current	Iidle	Vcc2=0.5V, Pin=off, Ven=1.8V Vmode=1.8V		30		mA	
Mode control current	Imode				0.1	mA	
Enable current	Ien				0.1	mA	
Leakage Current	Ioff	Vcc=3.4V, Pin=off, Ven=0V		5	10	µA	
2nd harmonic	2f0	HPM, Pout=Pmax		-37	-33	dBc	
3rd harmonic and higher	3f0	HPM, Pout=Pmax		-40	-35	dBc	
Input impedance VSWR	ρIN	HPM, Pout=Pmax		1.3:1	2.5:1		

■ Electrical performance-2

Vcc1=3.4V, Ven=1.8V, Ta=+25 °C, ZS=ZL=50 ohm

f=814 to 862MHz

Signal Condition: HSPA

Parameter	Symbol	Condition	Min	Typ	Max	Unit	Notes
Adjacent channel leakage power ratio3	ACLR3	5MHz offset Pout = Pmax-MPR HPM:Vcc2=3.4V, LPM:Vcc2=1.14V		-41	-36	dBc	4
Adjacent channel leakage power ratio4	ACLR4	10MHz offset Pout = Pmax-MPR HPM:Vcc2=3.4V, LPM:Vcc2=1.14V		-56	-46	dBc	4

Maintenance/Discontinued

Maintenance/Discontinued includes following four product lifecycle stage.
(planned maintenance type, maintenance type, planned discontinued type, discontinued type)

Panasonic Corporation



■ Electrical performance-3

Vcc1=Vcc2=3.4V, Ven=1.8V, Ta=+25 °C, ZS=ZL=50 ohm
f=814 to 862MHz

Signal Condition: LTE

Parameter	Symbol	Condition	Min	Typ	Max	Unit	Notes
Adjacent channel leakage power ratio5	ACLR5	E-UTRA_ACLR Pout = Pmax-MPR HPM:Vcc2=3.4V,LPM:Vcc2=1.14V		-38	-33	dBc	4,5
Adjacent channel leakage power ratio6	ACLR6	UTRA_ACLR1 Pout = Pmax-MPR HPM:Vcc2=3.4V,LPM:Vcc2=1.14V		-40	-36	dBc	4,5
Adjacent channel leakage power ratio7	ACLR7	UTRA_ACLR2 Pout = Pmax-MPR HPM:Vcc2=3.4V,LPM:Vcc2=1.14V		-47	-39	dBc	4,5

■ Electrical performance-4

Vcc1=Vcc2=3.4V, Ven=1.8V, Ta=+25 °C, ZS=ZL=50 ohm
f=814 to 862MHz

Parameter	Symbol	Condition	Min	Typ	Max	Unit	Notes
stability, spurious levels	S	Pout ≤ Pmax VSWR ≤ 5:1, all phase			-70	dBc	
Ruggedness	R	Pout ≤ Pmax all phase			8:1		

■ Electrical performance-5

Vcc1=Vcc2=3.4V, Ven=1.8V, Ta=+25 °C, ZS=ZL=50 ohm
f=814 to 862MHz

Parameter	Symbol	Condition	Min	Typ	Max	Unit	Notes
RX noise	NP1	Pout ≤ Pmax 45 MHz offset from Tx		-135	-133	dBm/Hz	
GPS noise	NP2	Pout ≤ Pmax 1574 to 1577 MHz		-140	-137	dBm/Hz	
ISM noise	NP3	Pout ≤ Pmax 2400 to 2483.5 MHz		-142	-135	dBm/Hz	

■ Electrical performance-6

Vcc1=Vcc2=3.4V, Ven=1.8V, Ta=+25 °C, ZS=ZL=50 ohm
f=814 to 862MHz

Signal Condition: LTE

Parameter	Symbol	Condition	Min	Typ	Max	Unit	Notes
RX noise	NP4	Pout ≤ Pmax 20RB, -41MHz offset from Tx		-132	-130	dBm/Hz	



■ Electrical performance-7

f=814 to 862MHz

Parameter	Symbol	Condition	Min	Typ	Max	Unit	Notes
Coupler factor	CF		19	20	21	dB	
Daisy-chain insertion loss	DCil	CPL_IN to CPL_OUT ports, 698 to 2620 MHz, Enable = low		0.1	0.25	dB	

■ Electrical performance-8

Vcc1=3.4V, Ven=1.8V, Ta=-30 to +85 °C, ZS=ZL=50 ohm
f=814 to 862MHz Signal Condition: Rel99, HSPA

Parameter	Symbol	Condition	Min	Typ	Max	Unit	Notes
Adjacent channel leakage power ratio8	ACLR8	5MHz offset Pout = Pmax-MPR-0.3dB HPM:Vcc2=3.4V,LPM:Vcc2=1.1V			-34	dBc	4
Adjacent channel leakage power ratio9	ACLR9	10MHz offset Pout = Pmax-MPR-0.3dB HPM:Vcc2=3.4V,LPM:Vcc2=1.1V			-46	dBc	4

■ Electrical performance-9

Vcc1=Vcc2=3.4V, Ven=1.8V, Ta=-30 to +85 °C, ZS=ZL=50 ohm
f=814 to 862MHz Signal Condition: LTE

Parameter	Symbol	Condition	Min	Typ	Max	Unit	Notes
Adjacent channel leakage power ratio10	ACLR10	E-UTRA_ACLR Pout = Pmax-MPR-0.3dB HPM:Vcc2=3.4V,LPM:Vcc2=1.14V			-31	dBc	4,5
Adjacent channel leakage power ratio11	ACLR11	UTRA_ACLR1 Pout = Pmax-MPR-0.3dB HPM:Vcc2=3.4V,LPM:Vcc2=1.14V			-34	dBc	4,5
Adjacent channel leakage power ratio12	ACLR12	UTRA_ACLR2 Pout = Pmax-MPR-0.3dB HPM:Vcc2=3.4V,LPM:Vcc2=1.14V			-37	dBc	4,5

■ Electrical performance-10

Vcc=3.4V, Ven=1.8V, Ta=+25 °C, ZS=ZL=50 ohm
f=814 to 862MHz Signal Condition: Rel99

Parameter	Symbol	Condition	Min	Typ	Max	Unit	Notes
Phase discontinuity variation	Pdv	Part to part variation	-10		10	deg	



■ Electrical performance-11

Vcc1=3.4V, Ven=1.8V, Ta=+25 °C, ZS=ZL=50 ohm
f=814 to 862MHz Signal Condition: CDMA2000

Parameter	Symbol	Condition	Min	Typ	Max	Unit	Notes
Adjacent channel Power ratio1	ACPR1	900kHz offset Pout = Pmax-MPR HPM:Vcc2=3.4V,LPM:Vcc2=1.1V		-50	-44	dBc	4
Adjacent channel Power ratio2	ACPR2	1.98MHz offset Pout = Pmax-MPR HPM:Vcc2=3.4V,LPM:Vcc2=1.1V		-58	-56	dBc	4

■ Electrical performance-12

Vcc1=3.4V, Ven=1.8V, Ta=-30 to +85 °C, ZS=ZL=50 ohm
f=814 to 862MHz Signal Condition: CDMA2000

Parameter	Symbol	Condition	Min	Typ	Max	Unit	Notes
Adjacent channel Power ratio3	ACPR3	900kHz offset Pout = Pmax-MPR-0.5dB HPM:Vcc2=3.4V,LPM:Vcc2=1.1V			-44	dBc	4
Adjacent channel Power ratio4	ACPR4	1.98MHz offset Pout = Pmax-MPR-0.5dB HPM:Vcc2=3.4V,LPM:Vcc2=1.1V			-56	dBc	4

Notes

- 1: The backside ground of the package should be soldered to cellular phone P.C.B.
- 2: Ven=0V
- 3: Vcc1=Vcc2=3.4V, Ven=2.9V, Vmode=0V, RL=50 ohm
- 4: RF measurements shall be made with 3GPP TS25.101 (UTRA/FDD UE), TS36.101 (LTE) and 3GPP2 specification compliant waveforms.
 - a. MPR is the maximum power reduction, as defined by the 3GPP specifications.
In case of using waveforms with a higher peak-to-average ratio, MPR shall be applied. (ranging from 0 to 2.5 dB)
 - b. The worst-case MPR = 0 dB waveforms across the 3GPP specifications are required to meet a 1.25 dB lower maximum power than 3GPP TS25.101 Rel99 case.
- 5: The LTE ACLR test is as defined in TS36.101, Section 6.6.2.3.
 - a. The minimum requirement of E-UTRA_ACLR is defined in Section 6.6.2.3.1.
 - b. The minimum requirement of UTRA_ACLR is defined in Section 6.6.2.3.2.
- 6: The signal configurations with A-MPR(NS-10) are referred to 3GPP TS36.101 6.2.4.



■ Look-up Table for Vcc Optimization

Pout [dBm]	Vcc [V] (HPM , LPM)		
	R99	HSPA / LTE	CDMA2000
28.5	3.40		
28.25	3.40		
28	3.32		
27	3.01	3.40	3.40
26	2.73	3.16	3.01
25	2.49	2.87	2.73
24	2.26	2.61	2.49
23	2.07	2.37	2.26
22	1.89	2.16	2.07
21	1.74	1.98	1.89
20	1.60	1.81	1.74
19	1.47	1.67	1.60
18	1.36	1.54	1.47
17	1.27	1.42	1.36
16	1.18	1.31	1.27
15	1.10	1.22	1.18
14	1.03	1.14	1.10
13	0.97	1.06	1.03
12	0.91	1.00	0.97
11	0.86	0.94	0.91
10	0.82	0.89	0.86
9	0.78	0.84	0.82
8	0.75	0.80	0.78
7	0.71	0.76	0.75
6	0.69	0.73	0.71
5	0.66	0.70	0.69
4	0.64	0.67	0.66
3	0.62	0.65	0.64
2	0.60	0.63	0.62
1	0.59	0.61	0.60
0	0.57	0.60	0.59
-5	0.52	0.54	0.53
-10	0.50	0.50	0.50
-15	0.48	0.48	0.48
-20	0.47	0.47	0.47

Discontinued
 (planned maintenance, discontinued type)
 Maintenance (planned maintenance, discontinued type)
 Following our Product lifecycle stage.

Panasonic

■ Marking

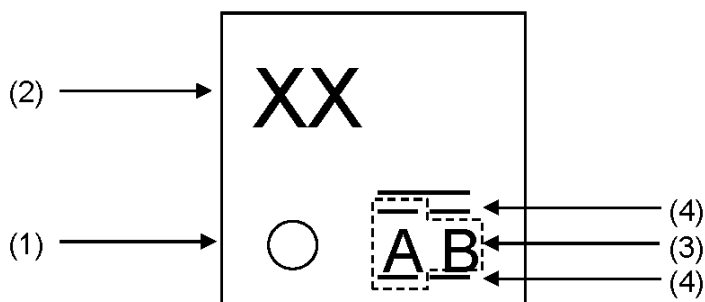

(1) Pin No.1

(2) Product Name

XX : XX shows UN06B05

(3) Lot No.

A B

A: 1 to 9, A to Z and the top and bottom bar are jointly used.

(However, neither I, O nor Q are used)

B: A to Z are jointly used. (However, neither I, O nor Q are used)

(4) Product Year

Product year is shown by an upper and lower bar.

bar	year
<u>A</u> <u>B</u> Upper and lower bar	2012
<u>A</u> <u>B</u> Upper bar	2013
AB without bar	2014
<u>A</u> <u>B</u> Lower bar	2015

It uses after 2016 repeatedly from the Upper and lower bar.



■ Outline Drawing
PAMP09-N3

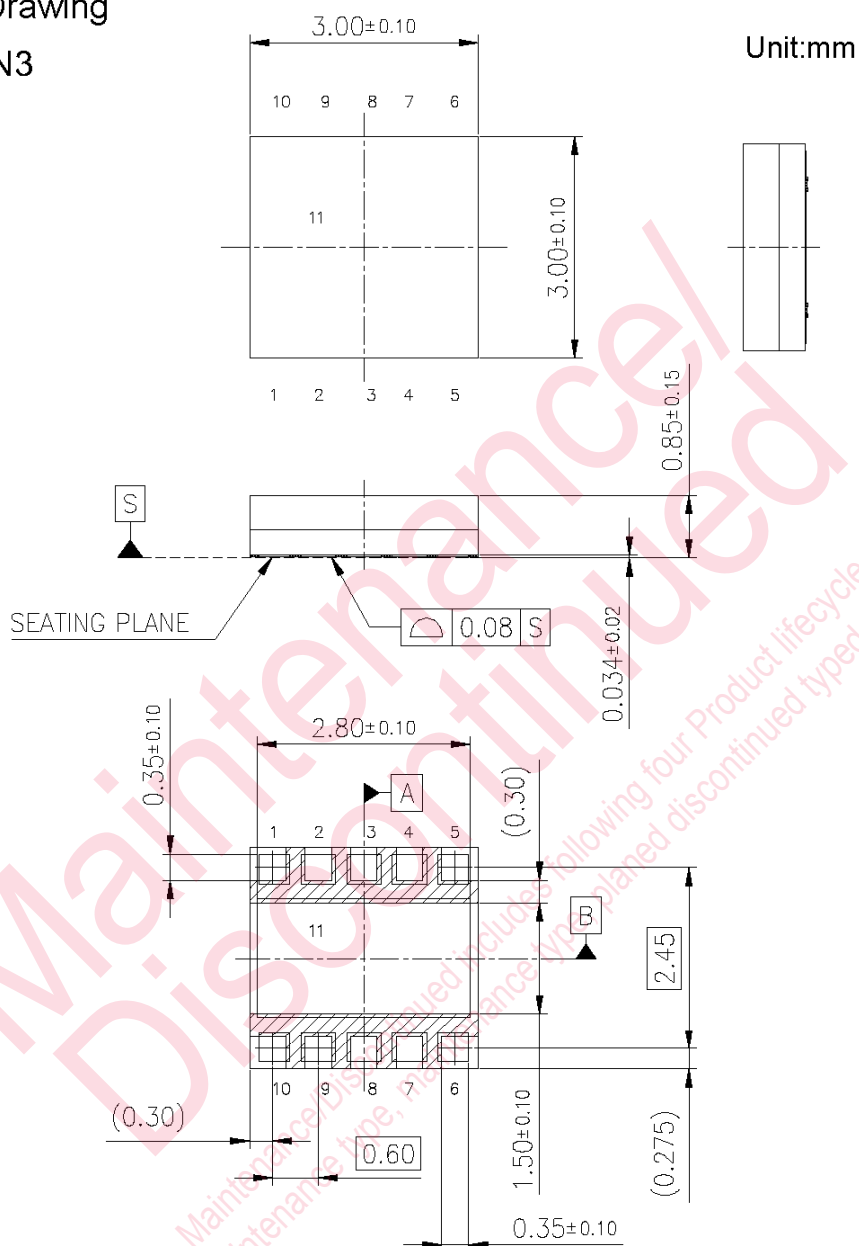

Body Material:	Epoxy Resin
Substrate Material:	Halogen Free Organic Substrate
Terminal Finish Method:	Electroless Au plating

■ Recommended land pattern

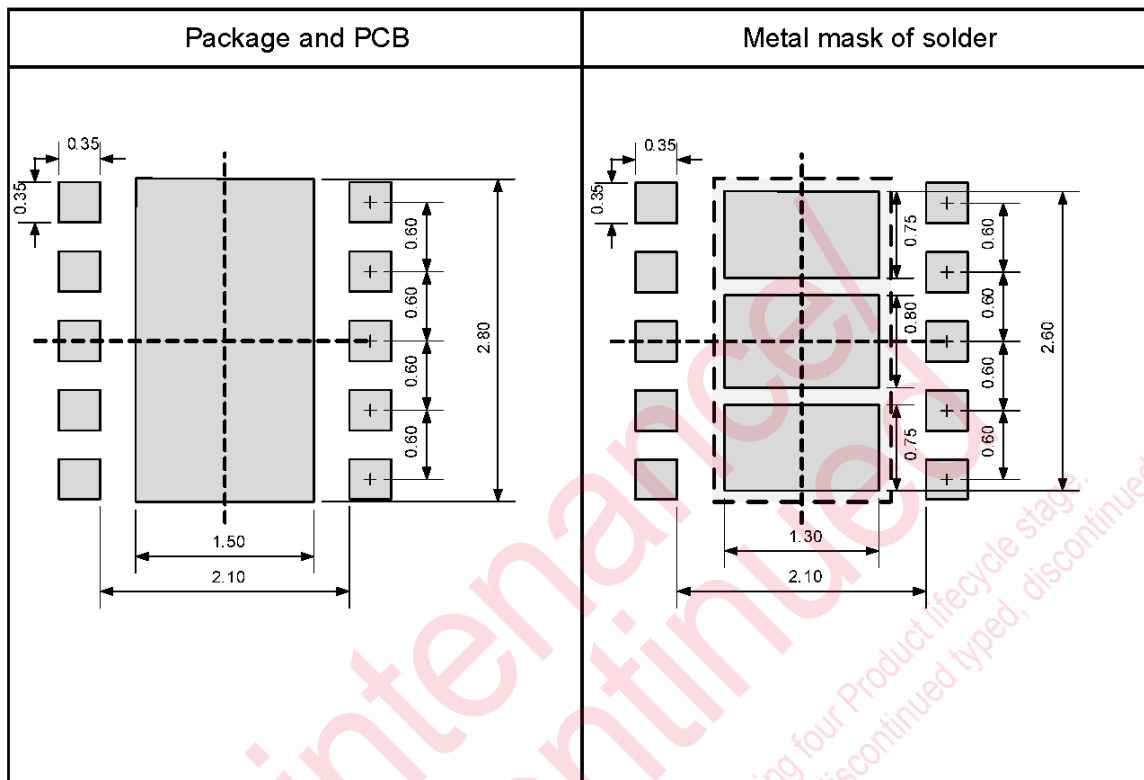

Maintenance/Discontinued includes following four Product lifecycle stage.
 (planned maintenance type, maintenance type, planned discontinued type, discontinued type)

Panasonic

■ Packing figure

1) Taping form

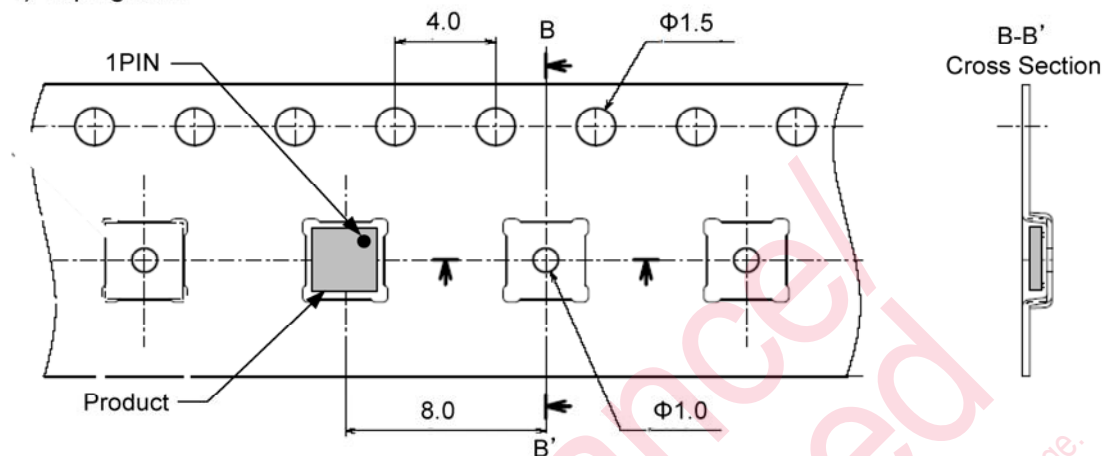

2) Reel form

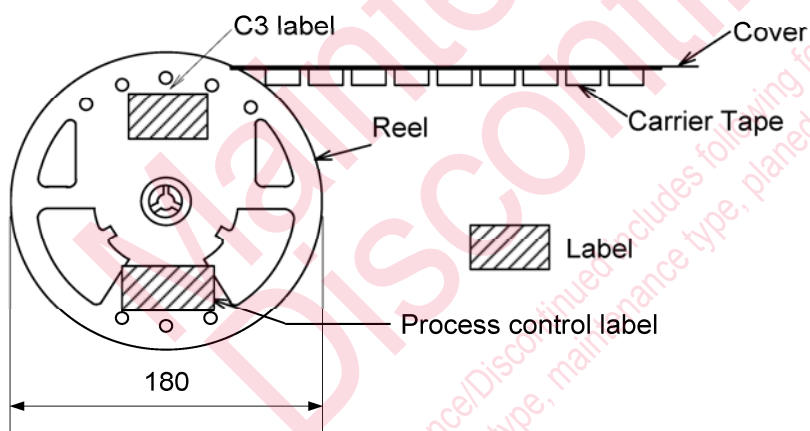

Reel, Carrier Tape and Covered Tape is antistatic treatment.
The lack of the product is not permitted.

■ Recommended reflow temperature profile in lead-free soldering

In reflow soldering process, exact temperature-cycle management is essential. We recommend pre-heating before soldering, so that you can prevent not only package damages or stains but also damages on a printed circuit board, and your process becomes stable.

The following shows our recommended reflow temperature profile.

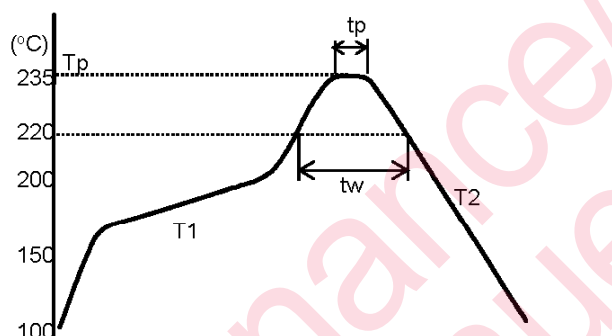

Pre-heating temp	T1	160 °C to 180 °C, 1 to 2 minutes
Peak temp	Tp	Below 235 °C
Heating time	tp	Below 10sec. (over 230 °C)
Storage time in high temp	tw	Over 30sec. (over 220 °C)
Cooling time	T2	Over 2minutes. (natural neglect in normal temperature)

Fig. 1 Solder wettability line

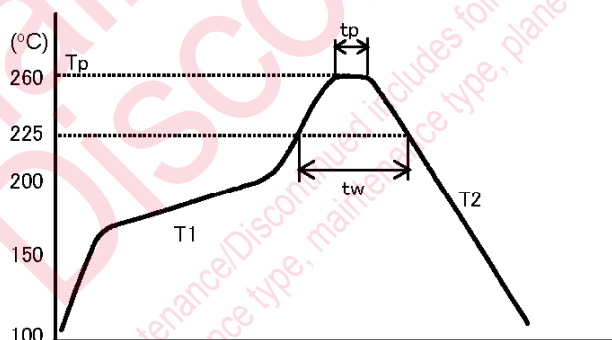

Pre-heating temp	T1	150 °C to 190 °C, 1 to 3 minutes
Peak temp	Tp	Below 260 °C
Heating time	tp	Below 10sec. (over 255 °C)
Storage time in high temp	tw	30 to 70sec. (over 225 °C)
Cooling time	T2	Over 2minutes. (natural neglect in normal temperature)
Reflow soldering times		2 times

Fig. 2 Solder heat resistance line

Note1 : Specified temperature is package surface temperature.

Note2 : N2 reflow is available.

Note3 : Available solder is Sn-3.0Ag-0.5Cu.

■ Notes on handling

- 1 Please, be fully careful of sudden heat, rapid cooling, and local heating, because this product is made by the resin board and the epoxy resin on structure. Please don't use the product dropped from higher place, because there is a risk of damage about the resin used in low elastic modulus by fall, a shock and so on.
- 2 Please, don't touch Au plating area of product by bare hand, and don't hurt, because Au is plated on the product electrode as exterior plating.
- 3 You must finish mount and reflow soldering within seven days after opening the dry pack in order to prevent exposure of moisture. Please keep the product at the atmosphere of the temperature from 5 °C to 30 °C and the humidity from 30%RH to 70%RH. Please keep the product in stable place of temperature and humidity without corrosive gas. If you keep product in that stable place, you may mount and reflow soldering in three months.
- 4 Please prevent product from an excessive stress when you mount to a print board, Moreover, please avoid the mechanical chucking of a product.
- 5 Although it is impossible to use the strong acid as the solder flux, it is possible to use the one of a rosin material. The method of reflow soldering is our recommendation. Please refer a temperature profile of reflow soldering as shown in Fig. 1 at the page 15 of this document. In addition, please refer a recommendation of land pattern as shown in the figure of the page 13 of this document.
- 6 Please don't carry out washing using a solvent after reflow soldering. also by ultrasonic wave cleaning.
- 7 Please be careful not to expose product static electricity, surge, etc.

■ Handling of dry packed products

1. Adaptation

In order to realize stable soldering, We ship this product with dry packing. Please take care with the following point, when you use dry packed products.

2. The storage conditions of a product

Be careful enough of storage environment irrespective of opening or un-opening. The product storage should avoid getting wet, corrosive gas, and fire.

[Recommended storage environment]

Temperature: 5 to 30 °C

Humidity: 30 to 70%RH

Period: Less than 1 year

(Within 1 year after the manufacture date code of C3 label)

3. Handling after opening dry packing

In order to avoid the moisture absorption to a product, after opening dry packing should finish mounting and reflow soldering altogether within regulation time.

[The period which can be after opening dry packing]

Period: 7 + 7 days

In the case of storage in recommended storage environment

<Attention>

Packing specification of this product is taping.

Taping material is not heat-resistant materials.

Therefore, you must finish mount and reflow soldering within regulation time.

Unavoidably If you can't finish within regulation time, you must bake the products by low-temperature baking conditions.

4. Low-temperature baking conditions

Please carry out product re-dryness in the taping state on the following conditions.

[Low-temperature baking conditions]

Temperature: 40 °C +/- 5 °C

Humidity: Less than 25%RH

Time: 192 hours

Number of times: 1 time



Caution for Safety



DANGER

This product contains Gallium Arsenide (GaAs).

GaAs powder and vapor are hazardous to human health if inhaled or ingested. Do not burn, destroy, cut, cleave off, or chemically dissolve the product. Follow related laws and ordinances for disposal. The product should be excluded from general industrial waste or household garbage.

Request for your special attention and precautions in using the technical information and semiconductors described in this book

- (1) If any of the products or technical information described in this book is to be exported or provided to non-residents, the laws and regulations of the exporting country, especially, those with regard to security export control, must be observed.
- (2) The technical information described in this book is intended only to show the main characteristics and application circuit examples of the products. No license is granted in and to any intellectual property right or other right owned by Panasonic Corporation or any other company. Therefore, no responsibility is assumed by our company as to the infringement upon any such right owned by any other company which may arise as a result of the use of technical information de-scribed in this book.
- (3) The products described in this book are intended to be used for general applications (such as office equipment, communications equipment, measuring instruments and household appliances), or for specific applications as expressly stated in this book.
Please consult with our sales staff in advance for information on the following applications, moreover please exchange documents separately on terms of use etc.: Special applications (such as for in-vehicle equipment, airplanes, aerospace, automotive equipment, traffic signaling equipment, combustion equipment, medical equipment and safety devices) in which exceptional quality and reliability are required, or if the failure or malfunction of the products may directly jeopardize life or harm the human body.
Unless exchanging documents on terms of use etc. in advance, it is to be understood that our company shall not be held responsible for any damage incurred as a result of or in connection with your using the products described in this book for any special application.
- (4) The products and product specifications described in this book are subject to change without notice for modification and/or improvement. At the final stage of your design, purchasing, or use of the products, therefore, ask for the most up-to-date Product Standards in advance to make sure that the latest specifications satisfy your requirements.
- (5) When designing your equipment, comply with the range of absolute maximum rating and the guaranteed operating conditions (operating power supply voltage and operating environment etc.). Especially, please be careful not to exceed the range of absolute maximum rating on the transient state, such as power-on, power-off and mode-switching. Otherwise, we will not be liable for any defect which may arise later in your equipment.
Even when the products are used within the guaranteed values, take into the consideration of incidence of break down and failure mode, possible to occur to semiconductor products. Measures on the systems such as redundant design, arresting the spread of fire or preventing glitch are recommended in order to prevent physical injury, fire, social damages, for example, by using the products.
- (6) Comply with the instructions for use in order to prevent breakdown and characteristics change due to external factors (ESD, EOS, thermal stress and mechanical stress) at the time of handling, mounting or at customer's process. We do not guarantee quality for disassembled products or the product re-mounted after removing from the mounting board.
When using products for which damp-proof packing is required, satisfy the conditions, such as shelf life and the elapsed time since first opening the packages.
- (7) When reselling products described in this book to other companies without our permission and receiving any claim of request from the resale destination, please understand that customers will bear the burden.
- (8) This book may be not reprinted or reproduced whether wholly or partially, without the prior written permission of our company.