

## **Notification about the transfer of the semiconductor business**

The semiconductor business of Panasonic Corporation was transferred on September 1, 2020 to Nuvoton Technology Corporation (hereinafter referred to as "Nuvoton"). Accordingly, Panasonic Semiconductor Solutions Co., Ltd. became under the umbrella of the Nuvoton Group, with the new name of Nuvoton Technology Corporation Japan (hereinafter referred to as "NTCJ").

In accordance with this transfer, semiconductor products will be handled as NTCJ-made products after September 1, 2020. However, such products will be continuously sold through Panasonic Corporation.

Publisher of this Document is NTCJ.

If you would find description "Panasonic" or "Panasonic semiconductor solutions", please replace it with NTCJ.

※ Except below description page

"Request for your special attention and precautions in using the technical information and semiconductors described in this book"

**Nuvoton Technology Corporation Japan**

Type	Silicon MOSFET type Integrated Circuit		
Application	For Switching Power Supply Control		
Structure	Bi-CMOS type		
Equivalent Circuit	Figure 7		
Package	DIP7-A1-B	Marking	MIP6S20

**A . ABSOLUTE MAXIMUM RATINGS**

No.	Item	Symbol	Ratings	Unit	Note
1	Drain Voltage	DRAIN	- 0.3 ~ 700	V	Tc = 25
2	Drain Peak Current	IDP	6	A	Tc = 25
3	VCC Voltage	VCC	- 0.3 ~ 45	V	Tc = 25
4	VDD Voltage	VDD	- 0.3 ~ 10	V	Tc = 25
5	LS Voltage	VLS	- 0.3 ~ 10	V	Tc = 25
6	IS Voltage	VIS	- 0.3 ~ 5	V	Tc = 25
7	FB Voltage	VFB	- 0.3 ~ 8	V	Tc = 25
8	Junction Temperature	Tj	150		Control IC& Power MOSFET
9	Storage Temperature	Tstg	- 55 ~ + 150		

**B . RECOMMENDED OPERATING CONDITIONS**

No.	Item	Symbol	Conditions	Unit	Note
1	Junction Temperature (Control IC)	Tjcon	- 40 ~ +100		
2	Junction Temperature (Power MOSFET)	Tjmos	- 40 ~ +150		
3	VCC operation voltage range at Heavy Load	VCC	13 ~ 28	V	

**C . ELECTRICAL CHARACTERISTICS** Measurement conditions (Ta=25 ±3 )

NO.	Item	Symbol	Measurement Conditions	Typ.	Min.	Max.	Unit
[CONTROL FUNCTIONS] *Design Guarantee Item, **Reference Item							
1	VCC Start Voltage	VCC(ON)		18.5	17.0	20.0	V
2	VCC Stop Voltage	VCC(OFF)		10.8	9.8	11.8	V
3	VCC Start/Stop Hysteresis	D_VCC	VCC(ON) - VCC(OFF)	7.7	6.9	8.8	V
4	VDD Reference Voltage	VDD	VCC = 21 V	5.9	5.6	6.2	V
5	Circuit Current before start	ICC (SB)	VCC = VCC(ON) - 0.8 V, FB : open	0.58	0.48	0.68	mA
6	Operating Circuit Current at light load	ICC (STB)	VCC = 15 V, IFB = IFB1 10 μA	0.51	0.45	0.56	mA
**7	Operating Circuit Current	ICC(OP)	VCC = 21 V, IFB = -20 μA, DRAIN = 5 V	2.00	-	-	mA
8	Operating Circuit Current at Over Load Protection	ICC(OL)	VCC = 15 V VFB = VFB(OL) open	0.85	0.70	1.00	mA
9	Output Frequency	fosc	VCC = 21 V, VFB = 3 V, DRAIN = 5 V	66	61	71	kHz
10	Jitter Frequency Deviation	d_fosc	VCC = 21 V, VFB = 3 V, DRAIN = 5 V	3.0	1.8	4.2	kHz
**11	Jitter Frequency Modulation Rate	fM	VCC = 21 V, VFB = 3 V, DRAIN = 5 V	350	-	-	Hz
12	Maximum Duty Cycle	MAXDC	VCC = 21 V, VFB = 3 V, DRAIN = 5 V	66	60	72	%
13	Feedback Threshold Current	IFB1	ON OFF, VCC = 21 V	-80	-104	-56	μA
**14	Feedback Current Hysteresis	IFBHYS	OFF ON, VCC = 21 V	1	-	-	μA
15	FB Pin Voltage	VFB1	VCC = 21 V, IFB = IFB1	1.6	1.4	1.8	V
16	FB Pin Grounded Current	IFB0	VCC = 21 V, VFB = 0 V	-330	-410	-250	μA
17	FB Pin Pull-down resistance at Output Stop	RFB(OFF)	VCC = 40 V, VFB = VFB1	400	250	550	

No.	Item	Symbol	Measure Conditions	Typ.	Min.	Max.	Unit
18	VCC Pin Charging Current	ICCH1	VCC = 0 V, FB : open, DRAIN = 50 V	-11.0	-15.4	-6.6	mA
		ICCH2	VCC = VCC(ON) - 0.5 V, FB : open, DRAIN = 50 V	-3.0	-5.0	-2.0	mA
*19	Soft Start Time	Tsoft	DRAIN = 50 V	6.0	3.5	8.5	ms
[CIRCUIT PROTECTIONS] *Design Guarantee Item, **Reference Item							
20	Current Limit Detection Maximum Voltage	VLIMIT(MAX)	VCC = 21 V, VFB = 3 V, DRAIN = 5 V	800	744	856	mV
21	Current Limit Detection Maximum Voltage at Input Compensation Mode	VLIMIT_L	VCC = 21 V, VFB = 3 V, VLS = 0.75 V, DRAIN = 5 V	710	660	760	mV
22	Slope Compensation Rate	VLIM_SLP	VCC = 21 V, VFB = 3 V	-19.5	-24.0	-14.5	mV/μs
*23	Start Duty Cycle of Slope Compensation	D_SLP	VCC = 21 V, VFB = 3 V	35.0	31.5	38.5	%
*24	Current Detection Minimum Voltage at light load	VIS(OFF)min	VCC = 21 V, IFB = IFB1, DRAIN = 5 V	160	110	210	mV
**25	Jitter Deviation of Current Detection Voltage at light load	D_VIS(OFF)	VCC = 21 V, IFB = IFB1, DRAIN = 5 V	40	-	-	mV
26	LS Pin Voltage of Input Compensation Detect	VLS(CL)	VCC = 21 V, VFB = 3 V, DRAIN = 5 V	520	468	572	mV
27	LS Pin Voltage of Input Compensation Release	VLS(CL)L	VCC = 21 V, VFB = 3 V, DRAIN = 5 V	470	423	517	mV
28	LS Pin Hysteresis Voltage of Input Compensation	VLS(CL)HYS	VCC = 21 V, VFB = 3 V, DRAIN = 5 V	60	45	75	mV
29	LS Pin Voltage of Over Input Protection Detect	VLS(OV)	VCC = 21 V, VFB = 3 V, DRAIN = 5 V	1.050	0.945	1.155	V
30	LS Pin Voltage of Over Input Protection Return	VLS(OV)L	VCC = 21 V, VFB = 3 V, DRAIN = 5 V	1.000	0.900	1.100	V
31	LS Pin Hysteresis Voltage of Over Input Protection	VLS(OV)HYS	VCC = 21 V, VFB = 3 V, DRAIN = 5 V	0.060	0.045	0.075	V
32	VCC timer Count at Over Load Protection	OLP_CNT	VCC = VCC(ON) VCC(OFF)	4			-
**33	Leading Edge Blanking Delay	Ton(BLK)		440	-	-	ns
**34	Current Limit Delay	Td(OCL)		150	-	-	ns
35	FB Over Load Protection detect Voltage	VFB(OL)	VCC = 22 V, DRAIN = 5 V	4.4	4.1	4.7	V
36	FB Current at heavy load	IFB(OL)	VCC = 22 V, VFB = 3 V, DRAIN = 5 V	-10	-13	-7	μA

No.	Item	Symbol	Measure Conditions	Typ.	Min.	Max.	Unit
37	VCC Over Voltage Protection	VCC(OV)	VFB = 3 V, DRAIN = 5 V	31.5	28.5	34.5	V
38	VDD Over Voltage Protection	VDD(OV)	VCC = 21 V, VFB = 3 V, DRAIN = 5 V	7.5	7.0	8.1	V
39	VDD current at VDD Over Voltage Protection	IDD(OV)	VCC = 21 V, VFB = 3 V, DRAIN = 5 V	1.2	0.7	1.7	mA
40	VDD Clamp Current	IDD(CLP)	VDD = 10 V	16.5	13.2	19.8	mA
**41	Over Load Protection Filter Time	Td(OL)	VCC = 21 V	20	-	-	μs
**42	Over Voltage Protection Latch Stop Filter Time	Td(LAT)	VCC = 21 V	150	-	-	μs
43	Latch Reset VDD Threshold Voltage	VDDreset		2.7	1.7	3.7	V
*44	Thermal Shutdown Temperature (Control IC)	TOTP		140	130.	150	
**45	Thermal Shutdown Temperature Hysteresis (Control IC)	TOTPHYS		70	-	-	

[Power MOSFET] \*Design Guarantee Item, \*\*Reference Item

46	Minimum Drain Supply Voltage	VD(MIN)		25.0	20.0	29.0	V
47	Breakdown Voltage	VDSS	VCC = 40 V, IDRAIN = 250 μA,	-	700	-	V
48	OFF-State leakage Current	IDSS	VCC = 40 V DRAIN = 650 V	2	-	7	μA
49	ON-State Resistance	RDS(ON)	VCC = 21 V, VFB = 3 V, IDRAIN = 1 A,	1.35	-	1.70	
**50	Rise Time	tr	VCC = 21 V, VFB = 3 V, DRAIN = 5 V	180	-	-	ns
**51	Fall Time	tf	VCC = 21 V, VFB = 3 V, DRAIN = 5 V	90	-	-	ns

【Figure 1 : Measurement circuit / Pin Layout】

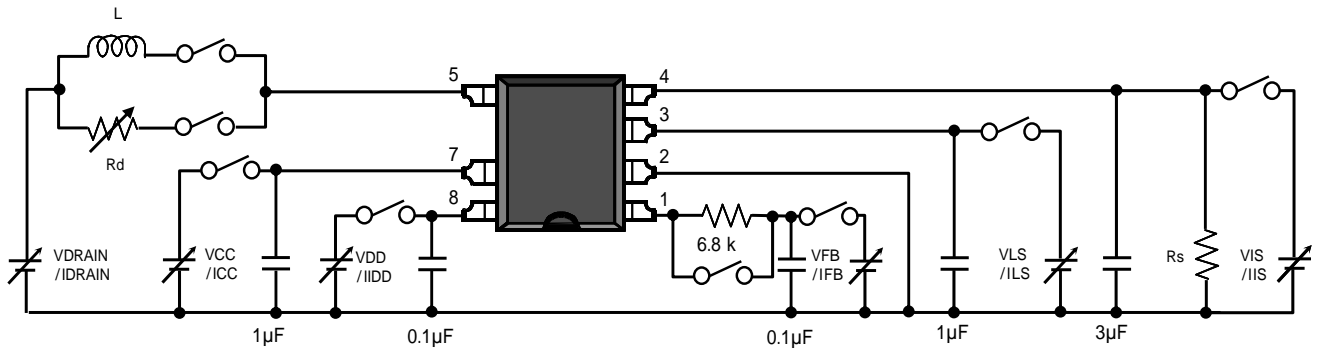

Pin No.	Pin Name	Function
1	FB	Feedback control
2	GND	Ground
3	LS	Input Compensation / Over Input Voltage Protection
4	IS	MOSFET Source / Current Detection
5	DRAIN	MOSFET Drain / Power supply for start-up
6		
7	VCC	Power supply from bias winding / Over Voltage Protection
8	VDD	Reference Voltage for circuits / External latch Protection

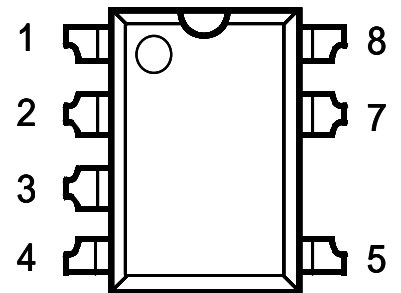

【Figure 2 : fosc, d\_fosc, fM measurement】

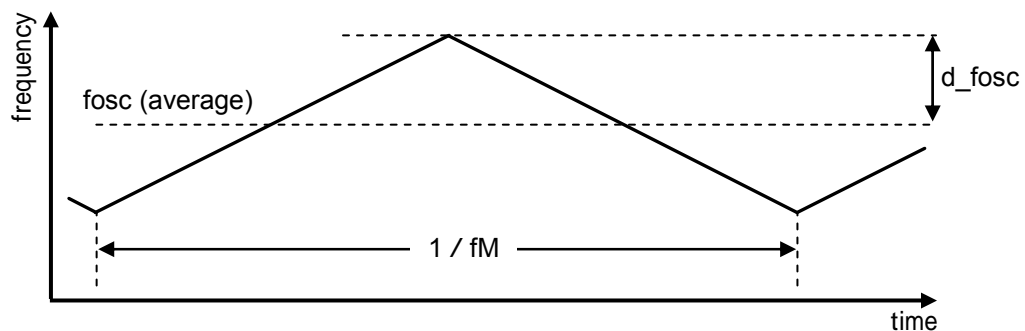

【Figure 3 : VLS - VLIMIT Characteristics】

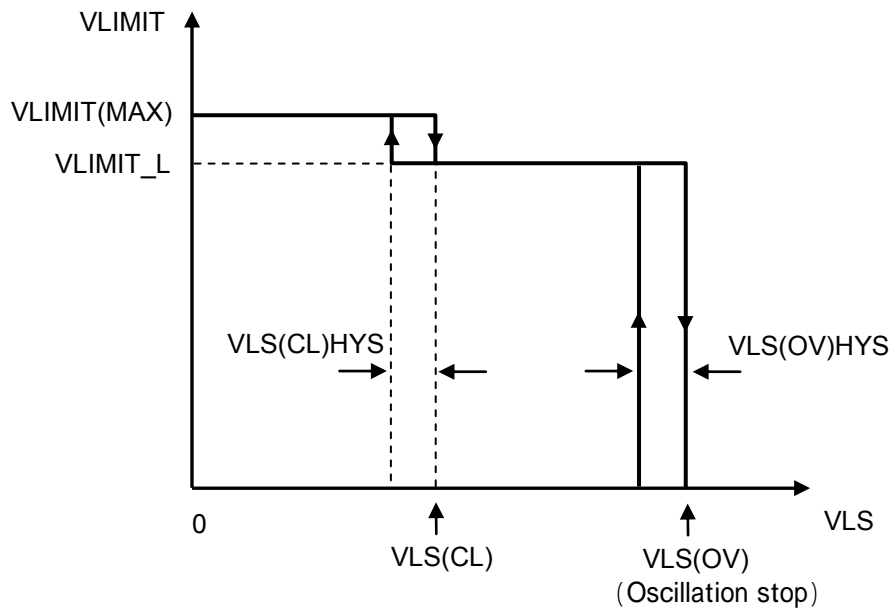

【Figure 4 : IFB - VLIMIT Characteristics】

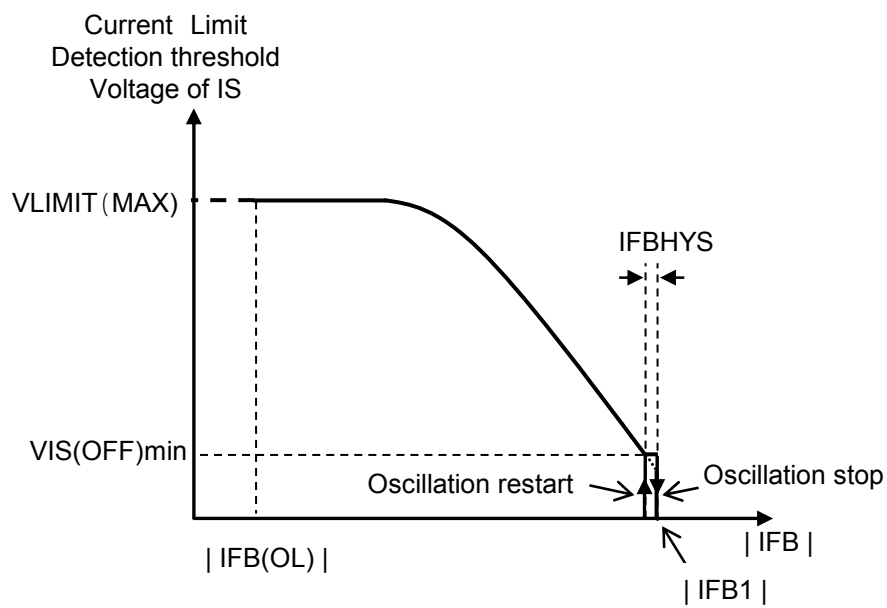

【Figure 5 : Over Load Protection Characteristics】

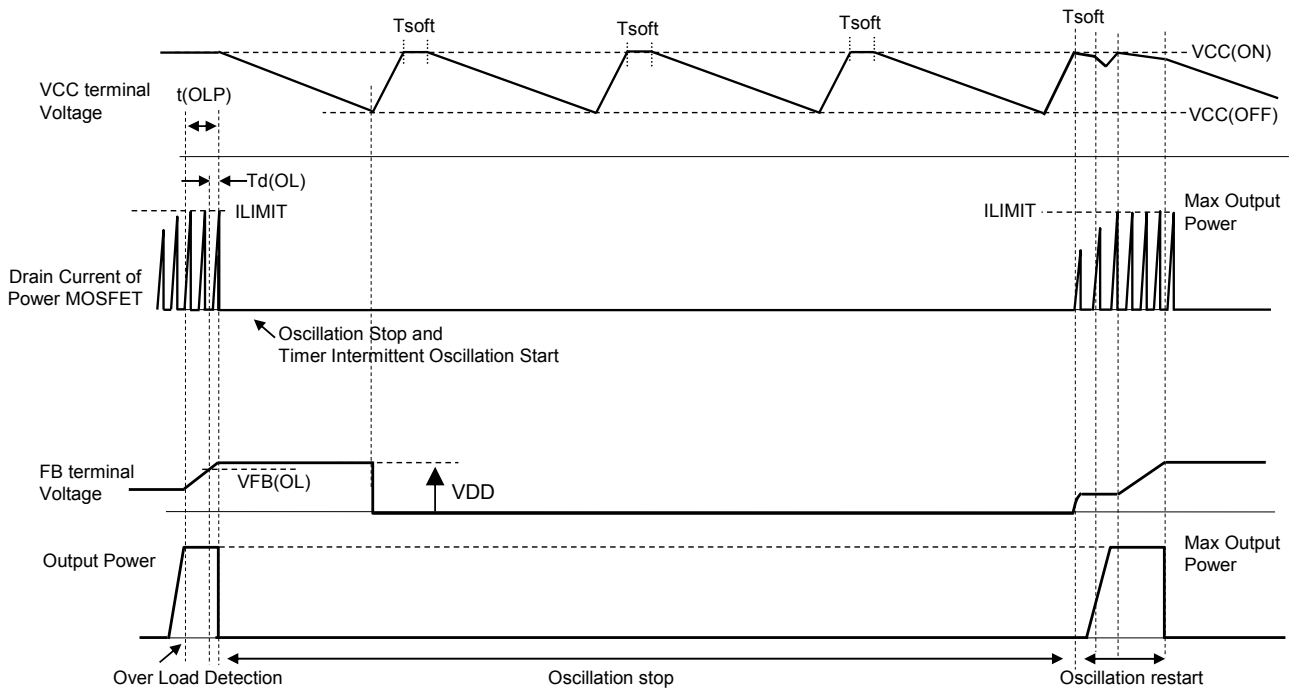

【Figure 6 :  $t_r$ ,  $t_f$  measurement】

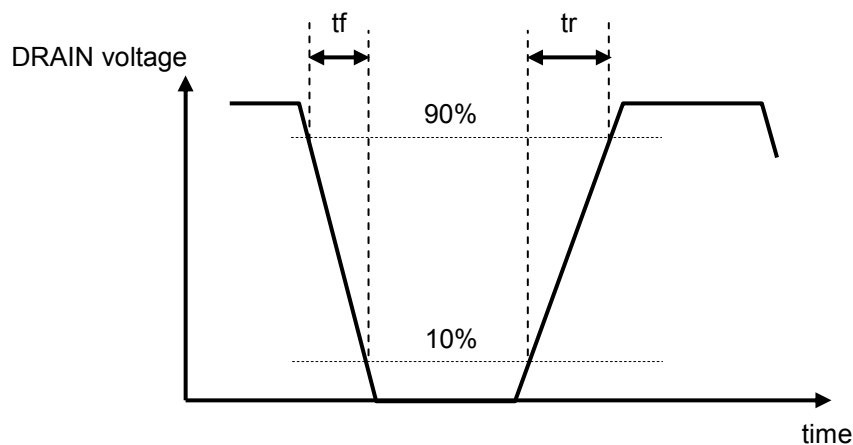



【Figure 7 : Block Diagram】

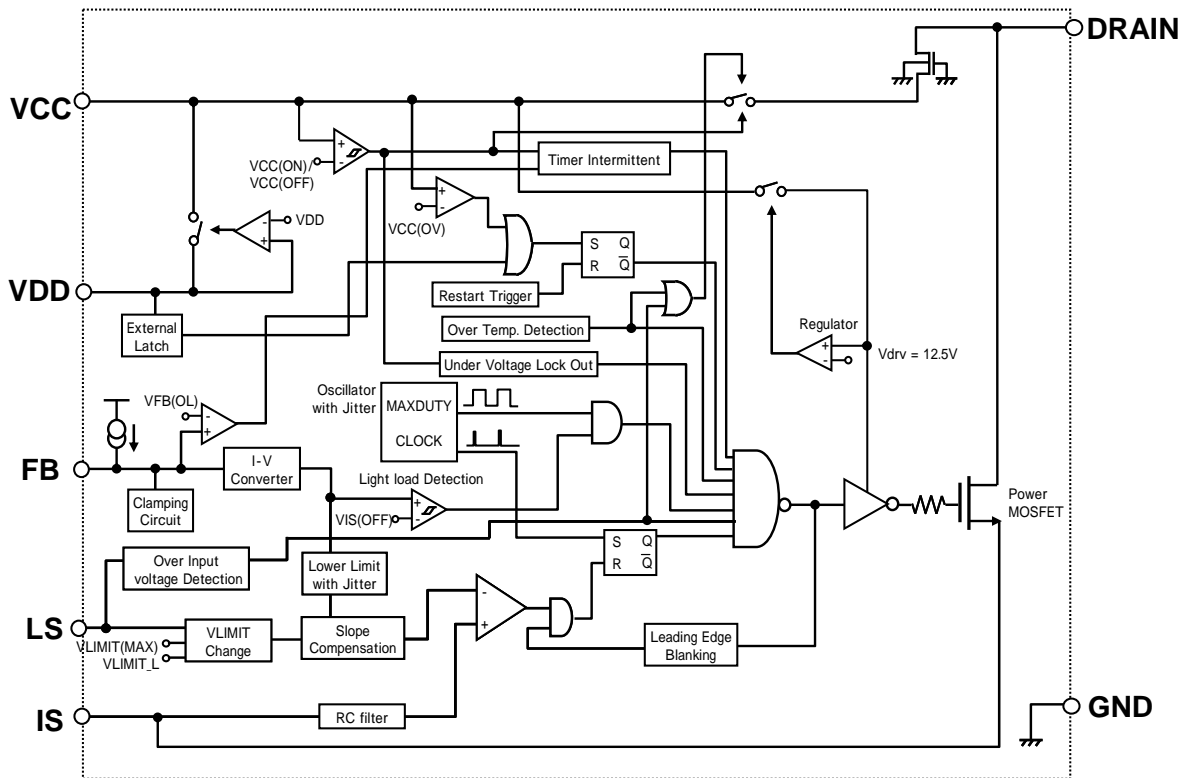

[Precautions for Use 1]

Connect a ceramic capacitor with value 0.1  $\mu$ F between VDD pin and GND

[Precautions for Use 2]

The product has risks for break-down or burst or giving off smoke in following conditions. Avoid the following use. Fuse should be added at the input side or connect Zener diode between control pin and GND, etc. as a countermeasure to pass regulatory Safety Standard. Concrete countermeasure could be provided individually. However, customer should make the final judgment.

- (1) Reverse the Drain pin and FB pin connection to the power supply board.
- (2) Connect to pins in which different Maximum ratings.

## Request for your special attention and precautions in using the technical information and semiconductors described in this book

- (1) If any of the products or technical information described in this book is to be exported or provided to non-residents, the laws and regulations of the exporting country, especially, those with regard to security export control, must be observed.
- (2) The technical information described in this book is intended only to show the main characteristics and application circuit examples of the products. No license is granted in and to any intellectual property right or other right owned by Panasonic Corporation, Nuvoton Technology Corporation Japan or any other company. Therefore, no responsibility is assumed by our company as to the infringement upon any such right owned by any other company which may arise as a result of the use of technical information de-scribed in this book.
- (3) The products described in this book are intended to be used for general applications (such as office equipment, communications equipment, measuring instruments and household appliances), or for specific applications as expressly stated in this book.  
Please consult with our sales staff in advance for information on the following applications, moreover please exchange documents separately on terms of use etc.: Special applications (such as for in-vehicle equipment, airplanes, aerospace, automotive equipment, traffic signaling equipment, combustion equipment, medical equipment and safety devices) in which exceptional quality and reliability are required, or if the failure or malfunction of the products may directly jeopardize life or harm the human body.  
Unless exchanging documents on terms of use etc. in advance, it is to be understood that our company shall not be held responsible for any damage incurred as a result of or in connection with your using the products described in this book for any special application.
- (4) The products and product specifications described in this book are subject to change without notice for modification and/or improvement. At the final stage of your design, purchasing, or use of the products, therefore, ask for the most up-to-date Product Standards in advance to make sure that the latest specifications satisfy your requirements.
- (5) When designing your equipment, comply with the range of absolute maximum rating and the guaranteed operating conditions (operating power supply voltage and operating environment etc.). Especially, please be careful not to exceed the range of absolute maximum rating on the transient state, such as power-on, power-off and mode-switching. Otherwise, we will not be liable for any defect which may arise later in your equipment.  
Even when the products are used within the guaranteed values, take into the consideration of incidence of break down and failure mode, possible to occur to semiconductor products. Measures on the systems such as redundant design, arresting the spread of fire or preventing glitch are recommended in order to prevent physical injury, fire, social damages, for example, by using the products.
- (6) Comply with the instructions for use in order to prevent breakdown and characteristics change due to external factors (ESD, EOS, thermal stress and mechanical stress) at the time of handling, mounting or at customer's process. We do not guarantee quality for disassembled products or the product re-mounted after removing from the mounting board.  
When using products for which damp-proof packing is required, satisfy the conditions, such as shelf life and the elapsed time since first opening the packages.
- (7) When reselling products described in this book to other companies without our permission and receiving any claim of request from the resale destination, please understand that customers will bear the burden.
- (8) This book may be not reprinted or reproduced whether wholly or partially, without the prior written permission of our company.