

## **Notification about the transfer of the semiconductor business**

The semiconductor business of Panasonic Corporation was transferred on September 1, 2020 to Nuvoton Technology Corporation (hereinafter referred to as "Nuvoton"). Accordingly, Panasonic Semiconductor Solutions Co., Ltd. became under the umbrella of the Nuvoton Group, with the new name of Nuvoton Technology Corporation Japan (hereinafter referred to as "NTCJ").

In accordance with this transfer, semiconductor products will be handled as NTCJ-made products after September 1, 2020. However, such products will be continuously sold through Panasonic Corporation.

Publisher of this Document is NTCJ.

If you would find description "Panasonic" or "Panasonic semiconductor solutions", please replace it with NTCJ.

※ Except below description page

"Request for your special attention and precautions in using the technical information and semiconductors described in this book"

**Nuvoton Technology Corporation Japan**

種別/Type	シリコン MOS形集積回路/Silicon MOSFET type Integrated Circuit						
用途/Application	スイッチング電源制御用/For a Switching Power Supply Control						
構造/Structure	CMOS形/CMOS type						
外形/Out Line	DIP7-A1-B	マーク記号/マーキング/Marking	MIP2E4D				
A. 絶対最大定格/ABSOLUTE MAXIMUM RATINGS (Ta=25°C±3°C)							
NO.	項目/Item	記号/Symbol	定格/Ratings	単位/Unit	備考/Note		
1	ドレイン電圧 DRAIN Voltage	VD	700	V			
2	コントロール電圧 CONTROL Voltage	VC	10	V			
3	出力電流 Output Current	ID	1.72	A			
4	出力ピーク電流 Output Peak Current	IDP	2.4	A			
5	コントロール電流 CONTROL Current	IC	0.1	A			
6	チャネル部温度 Channel Temperature	Tch	150	°C			
7	保存温度 Storage Temperature	Tstg	-55 ~ +150	°C			
B. 電気的特性/ELECTRICAL CHARACTERISTICS			測定条件/Measure condition (Tc=25°C±3°C)				
No.	項目/Item	記号/Symbol	測定条件/Measure Condition (別紙測定図-1 参照/ See Figure 1)	typ.	Limit		Unit
					Min	Max	
【コントロール機能/CONTROL FUNCTIONS: *は設計保証項目/Design Guarantee Item】							
1	出力周波数 Output Frequency	fOSC	Vc=Vc(GNT)-0.2V	100	90	110	kHz
2	最大デューティサイクル Maximum Duty Cycle	MAXDC	Vc=Vc(GNT)-0.2V	69	66	72	%
* 3	PWMゲイン PWM Gain	GPWM		11			dB
* 4	スロープ補償値 Slope Compensate Value	m		60			mA/us
【電源/SUPPLY: *は設計保証項目/Design Guarantee Item】							
5	起動前動作電流 Before Auto-restart Current	IC(SB)	Vc<Vc(ON) (2)	0.30	0.05	0.6	mA
6	動作時電流 Operating Current	IC(OP)	Vc=Vc(GNT)-0.2V (2)	1.8	0.7	2.7	mA
7	起動時コントロール端子電圧 Auto-restart Threshold Voltage	Vc(ON)	S1=OPEN (2)	6.0	5.1	6.6	V
8	停止時コントロール端子電圧 UV Lockout Threshold Voltage	Vc(OFF)	S1=OPEN (2)	5.0	4.1	5.5	V
9	起動/停止ヒステリシス電圧 Auto-restart hysteresis voltage	ΔVC	S1=OPEN (2)	1.0	0.5	1.5	V
10	間欠動作時間比 Auto-restart duty cycle	TSW/TTIM	S1=OPEN	2			%

No.	項目 / Item	記号 / Symbol	測定条件 / Measure Condition (別紙測定図-1 参照 / See Figure 1)	Typ.	Limit		Unit
					Min	Max	
11	間欠動作周波数 Auto-restart frequency	fTIM	S1=OPEN	0.5			Hz
12	コントロール端子充電電流 CONTROL Pin Charging Current	IC(CHG)	VC=0V	-1.9	-2.5	-1.2	mA
			VC=5V	-1.2	-2.0	-0.5	mA
13	コントロール電圧 CONTROL Pin Voltage	VC(CNT)		6.2	5.7	6.6	V
*14	コントロール電圧ヒステリシス CONTROL Pin Voltage hysteresis	$\Delta$ VC(CNT)		10			mV
15	最小ドレイン電圧 DRAIN Supply Voltage	VD(MIN)			36		V
【保護機能 / CIRCUIT PROTECTION: *は設計保証項目 / Design Guarantee Item】							
16	過電流保護検出 Self-protection Current Limit	ILIMIT		1.5	1.35	1.65	A
*17	オン時ブランキング幅 Leading Edge Blanking Delay	ton(BLK)		0.25			$\mu$ s
*18	過電流保護遅れ時間 Current Limit Delay	td(OCL)		0.1			$\mu$ s
*19	過熱保護温度 Thermal Shutdown Temperature	TOTP		140	130		$^{\circ}$ C
*20	ラッチリセット電圧 Power-up Reset Threshold Voltage	Vcreset	S2=OPEN	3.3	2.3	4.2	V
【出力 / OUTPUT: *は設計保証項目 / Design Guarantee Item】							
21	オン抵抗 On-State Resistance	RDS(ON)	ID=0.3A (See Figure 2)	5.8		6.7	$\Omega$
22	オフ時ドレイン端子リーク電流 OFF-State Current	IDSS	VDS=650V, Vc=6.5V	10		250	$\mu$ A
23	ドレイン耐圧 Breakdown Voltage	VDSS	ID=0.25mA, Vc=6.5V		700		V
24	立ち上がり時間 Rise time	tr	(1)	0.1			$\mu$ s
25	立ち下がり時間 Fall time	tf	(1)	0.1			$\mu$ s
*26	熱抵抗 Thermal resistance (j-a)	Rth (j-a)	エポキシ基板(3cm $\times$ 3cm)実装時 Ta=25 $^{\circ}$ C Surface Mounted on Epoxy Bord	90			$^{\circ}$ C/W

■測定回路図-1 / Figure 1

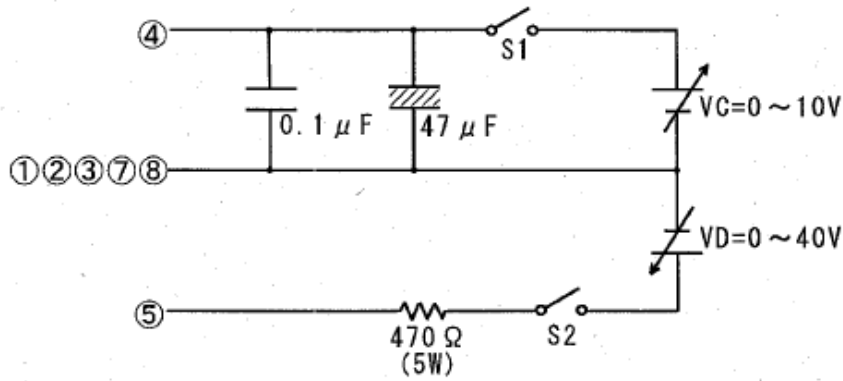

\* 本測定回路は、過電流保護検出値、出力特性の測定には使用できません。  
 This measurement circuit can't be useful for peak current and output characteristic measurement.

■測定回路図-2 / Figure 2

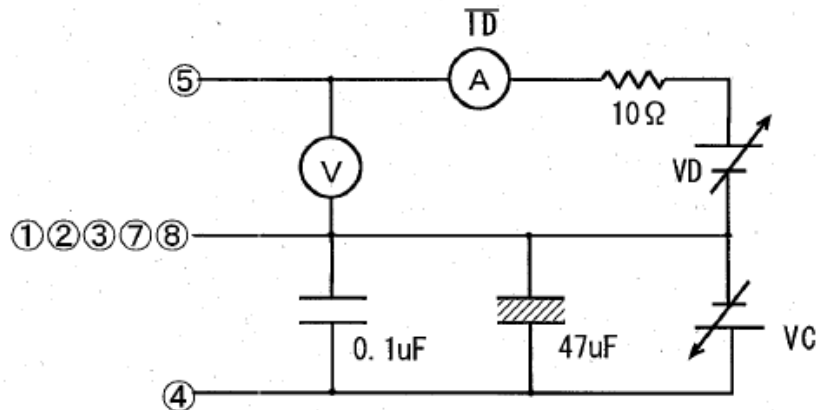

$$R_{on} = \frac{V_{D(ON)}}{I_D} \times \frac{t_{on}}{T}$$

端子説明 / Terminal explanation

- ④: Control
- ①②③⑦⑧: Source
- ⑤: Drain

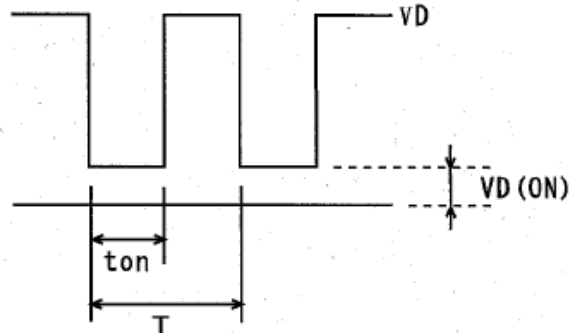

■測定回路図-3 / Figure 3

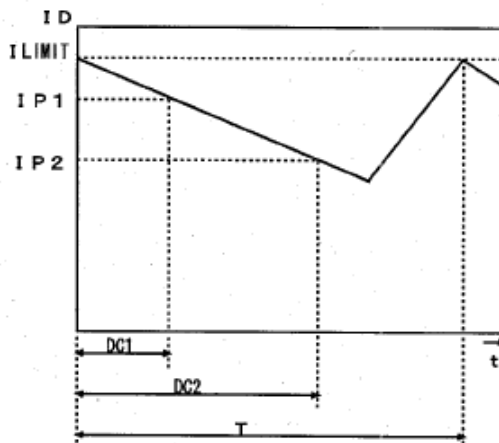
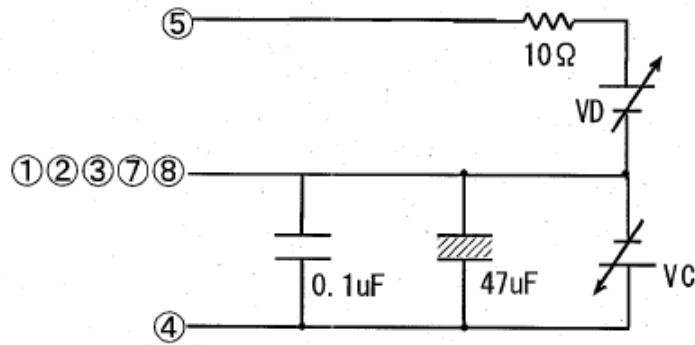

$$I_{LIMIT} = \frac{DC2 \cdot IP1 - DC1 \cdot IP2}{DC2 - DC1}$$

$$m = f_{OSC} \cdot \frac{IP1 - IP2}{DC2 - DC1}$$

端子説明 / Terminal explanation

- ④: Control
- ①②③⑦⑧: Source
- ⑤: Drain

\* DC1, DC2は、VDをそれぞれVD1, VD2にしたときのデューティサイクル(0<DC1<DC2<MAXDC)  
 / DC1,DC2 is duty cycle when VD is VD1 and VD2, respectively.

■ピン配置図／Pin alignment

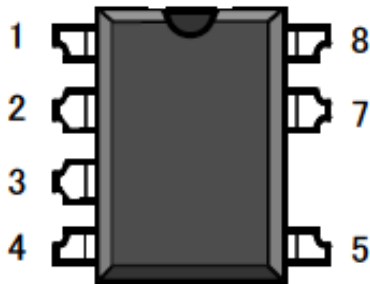

Pin No.	Pin name
1	Source
2	Source
3	Source
4	Control
5	Drain
6	—
7	Source
8	Source

NOTE: (1)

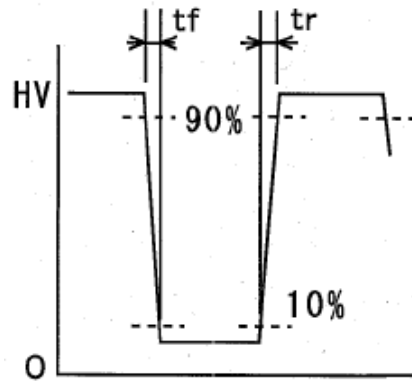

(2)

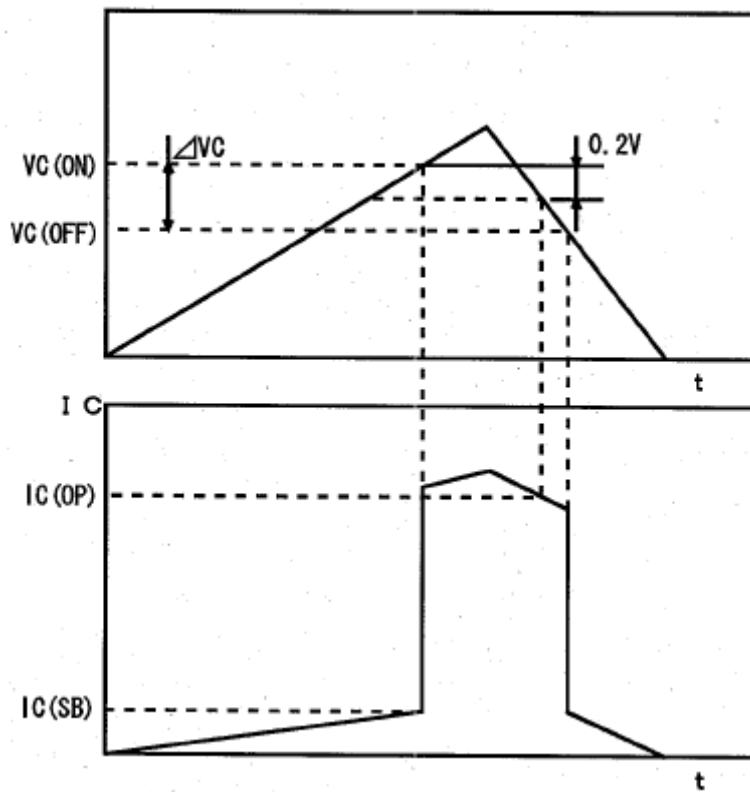

## Request for your special attention and precautions in using the technical information and semiconductors described in this book

- (1) If any of the products or technical information described in this book is to be exported or provided to non-residents, the laws and regulations of the exporting country, especially, those with regard to security export control, must be observed.
- (2) The technical information described in this book is intended only to show the main characteristics and application circuit examples of the products. No license is granted in and to any intellectual property right or other right owned by Panasonic Corporation, Nuvoton Technology Corporation Japan or any other company. Therefore, no responsibility is assumed by our company as to the infringement upon any such right owned by any other company which may arise as a result of the use of technical information de-scribed in this book.
- (3) The products described in this book are intended to be used for general applications (such as office equipment, communications equipment, measuring instruments and household appliances), or for specific applications as expressly stated in this book.  
Please consult with our sales staff in advance for information on the following applications, moreover please exchange documents separately on terms of use etc.: Special applications (such as for in-vehicle equipment, airplanes, aerospace, automotive equipment, traffic signaling equipment, combustion equipment, medical equipment and safety devices) in which exceptional quality and reliability are required, or if the failure or malfunction of the products may directly jeopardize life or harm the human body.  
Unless exchanging documents on terms of use etc. in advance, it is to be understood that our company shall not be held responsible for any damage incurred as a result of or in connection with your using the products described in this book for any special application.
- (4) The products and product specifications described in this book are subject to change without notice for modification and/or improvement. At the final stage of your design, purchasing, or use of the products, therefore, ask for the most up-to-date Product Standards in advance to make sure that the latest specifications satisfy your requirements.
- (5) When designing your equipment, comply with the range of absolute maximum rating and the guaranteed operating conditions (operating power supply voltage and operating environment etc.). Especially, please be careful not to exceed the range of absolute maximum rating on the transient state, such as power-on, power-off and mode-switching. Otherwise, we will not be liable for any defect which may arise later in your equipment.  
Even when the products are used within the guaranteed values, take into the consideration of incidence of break down and failure mode, possible to occur to semiconductor products. Measures on the systems such as redundant design, arresting the spread of fire or preventing glitch are recommended in order to prevent physical injury, fire, social damages, for example, by using the products.
- (6) Comply with the instructions for use in order to prevent breakdown and characteristics change due to external factors (ESD, EOS, thermal stress and mechanical stress) at the time of handling, mounting or at customer's process. We do not guarantee quality for disassembled products or the product re-mounted after removing from the mounting board.  
When using products for which damp-proof packing is required, satisfy the conditions, such as shelf life and the elapsed time since first opening the packages.
- (7) When reselling products described in this book to other companies without our permission and receiving any claim of request from the resale destination, please understand that customers will bear the burden.
- (8) This book may be not reprinted or reproduced whether wholly or partially, without the prior written permission of our company.