

Notification about the transfer of the semiconductor business

The semiconductor business of Panasonic Corporation was transferred on September 1, 2020 to Nuvoton Technology Corporation (hereinafter referred to as "Nuvoton"). Accordingly, Panasonic Semiconductor Solutions Co., Ltd. became under the umbrella of the Nuvoton Group, with the new name of Nuvoton Technology Corporation Japan (hereinafter referred to as "NTCJ").

In accordance with this transfer, semiconductor products will be handled as NTCJ-made products after September 1, 2020. However, such products will be continuously sold through Panasonic Corporation.

Publisher of this Document is NTCJ.

If you would find description "Panasonic" or "Panasonic semiconductor solutions", please replace it with NTCJ.

※ Except below description page

"Request for your special attention and precautions in using the technical information and semiconductors described in this book"

Nuvoton Technology Corporation Japan



FCAB22370L

Gate resistor installed Dual N-channel MOS FET

For lithium-ion secondary battery protection circuits

■ Features

- Low source-source ON resistance: $R_{ss(on)}$ typ. = 3.3 m Ω (VGS = 3.8 V)
- CSP (Chip Size Package)
- RoHS compliant (EU RoHS / MSL: Level 1 compliant)

■ Marking Symbol: 3P

■ Packaging

Embossed type (Thermo-compression sealing) : 10 000 pcs / reel (standard)

■ Absolute Maximum Ratings Ta = 25 °C

Parameter	Symbol	Rating	Unit
Source-source Voltage	VSS	20	V
Gate-source Voltage	VGS	±12	V
Source Current (DC) *1	IS	10	A
Source Current (Pulsed) *1,*2	ISp	100	A
Total Power Dissipation *1	PD	0.45	W
Channel Temperature	Tch	150	°C
Storage Temperature Range	Tstg	-55 to +150	°C
Thermal Resistance (ch-a)	Rth(ch-a)	278	°C/W

Note *1 Mounted on FR4 board (25.4 mm × 25.4 mm × t1.0 mm)
 using the minimum recommended pad size (36 μ m Copper).

*2 t = 10 μ s, Duty Cycle ≤ 1 %

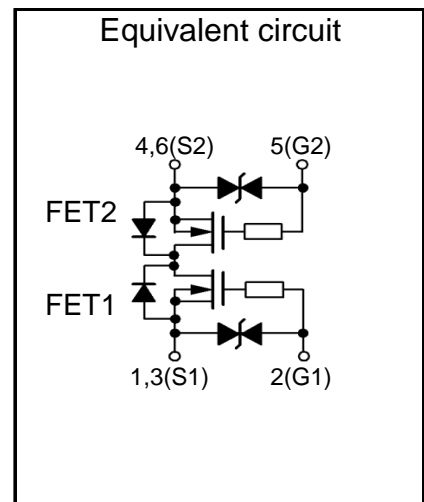
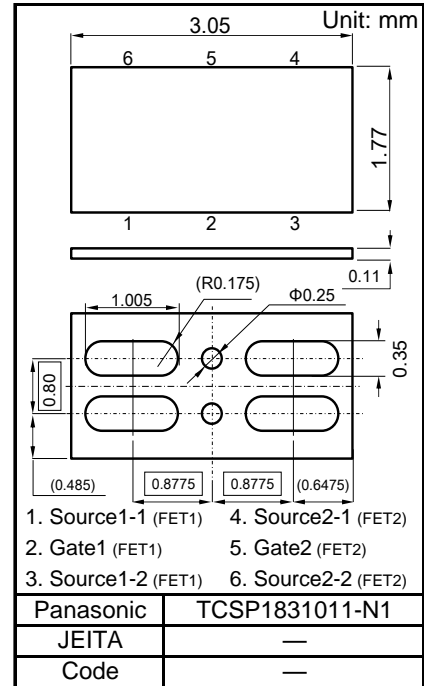

■ Electrical Characteristics Ta = 25 °C ± 3 °C

Parameter	Symbol	Conditions	Min	Typ	Max	Unit
Source-source Breakdown Voltage	VSSS	IS = 1 mA, VGS = 0 V	20			V
Zero Gate Voltage Source Current	ISSS	VSS = 20 V, VGS = 0 V			1.0	μA
Gate-source Leakage Current	IGSS	VGS = ±8 V, VSS = 0 V			±10	μA
		VGS = ±5 V, VSS = 0 V			±1.0	
Gate-source Threshold Voltage	Vth	IS = 1.41 mA, VSS = 10 V	0.35	0.90	1.4	V
Source-source On-state Resistance	RSS(on)1	IS = 5.0 A, VGS = 4.5 V	2.1	3.1	4.2	mΩ
	RSS(on)2	IS = 5.0 A, VGS = 3.8 V	2.2	3.3	4.3	
	RSS(on)3	IS = 5.0 A, VGS = 3.1 V	2.4	3.8	6.0	
	RSS(on)4	IS = 5.0 A, VGS = 2.5 V	2.6	4.6	9.0	
Body Diode Forward Voltage	VF(s-s)	IF = 5.0 A, VGS = 0 V		0.8	1.2	V
Input Capacitance ^{*1}	Ciss	VSS = 10 V, VGS = 0 V, f = 1 kHz		3700		pF
Output Capacitance ^{*1}	Coss			380		
Reverse Transfer Capacitance ^{*1}	Crss			340		
Turn-on delay Time ^{*1,2}	td(on)	VDD = 10 V, VGS = 0 to 4.0 V		0.9		μs
Rise Time ^{*1,2}	tr	IS = 5.0 A		2.0		
Turn-off delay Time ^{*1,2}	td(off)	VDD = 10 V, VGS = 4.0 to 0 V		6		μs
Fall Time ^{*1,2}	tf	IS = 5.0 A		3.7		
Total Gate Charge ^{*1}	Qg	VDD = 10 V		33		nC
Gate-source Charge ^{*1}	Qgs	VGS = 0 to 4.0 V,		11		
Gate-drain Charge ^{*1}	Qgd	IS = 5.0 A		9		
Gate Resistance ^{*1}	Rg	f = 1 kHz	400	700	1000	Ω

Note Measuring methods are based on JAPANESE INDUSTRIAL STANDARD JIS C 7030 Measuring methods for transistors.

*1 Guaranteed by design, not subject to production testing

*2 Measurement circuit for Turn-on Delay Time / Rise Time / Turn-off Delay Time / Fall Time

Note2 : Measurement circuit

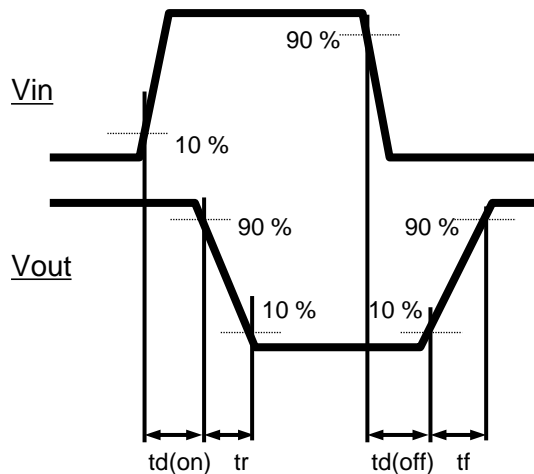
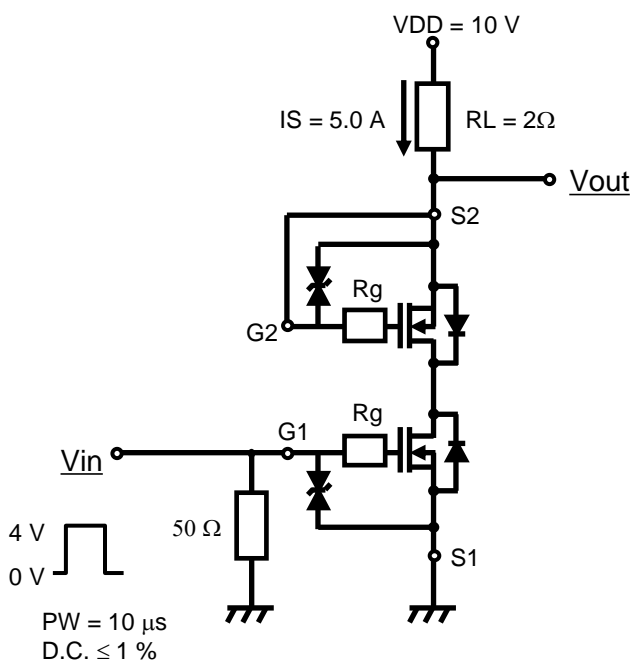

Technical Data (reference)

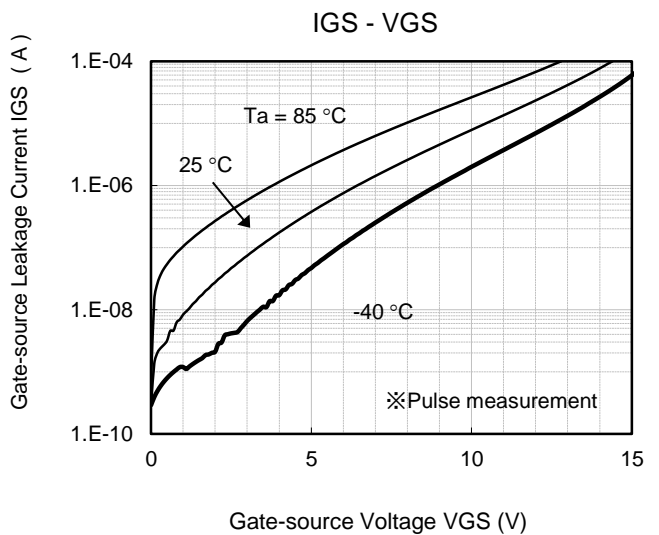
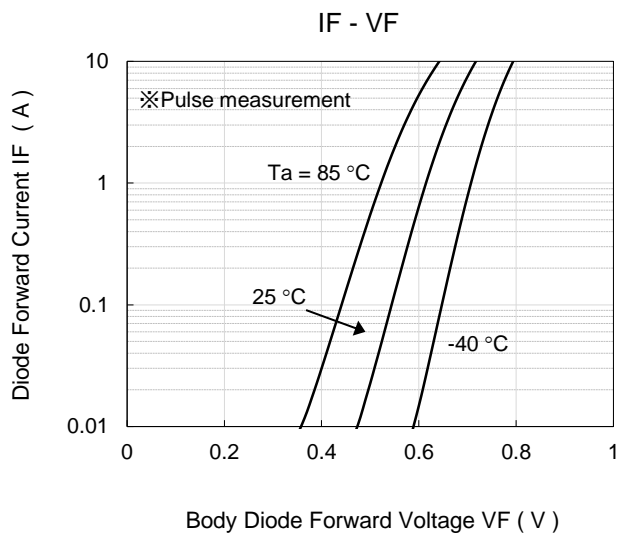
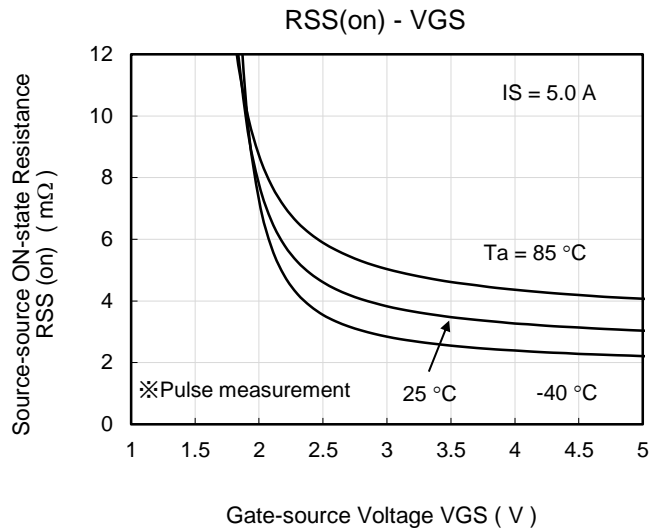
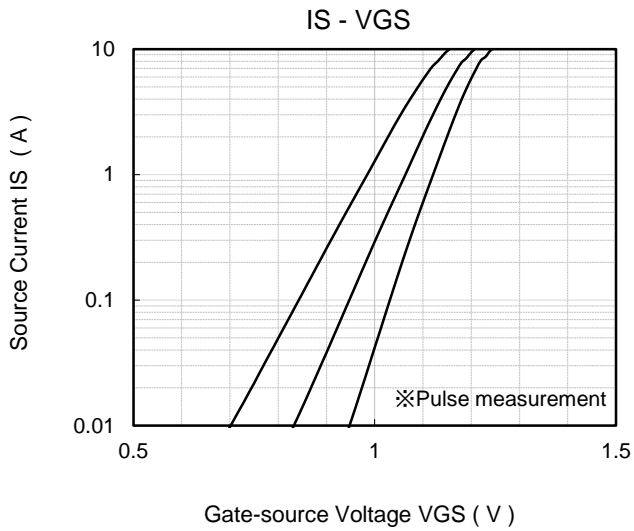
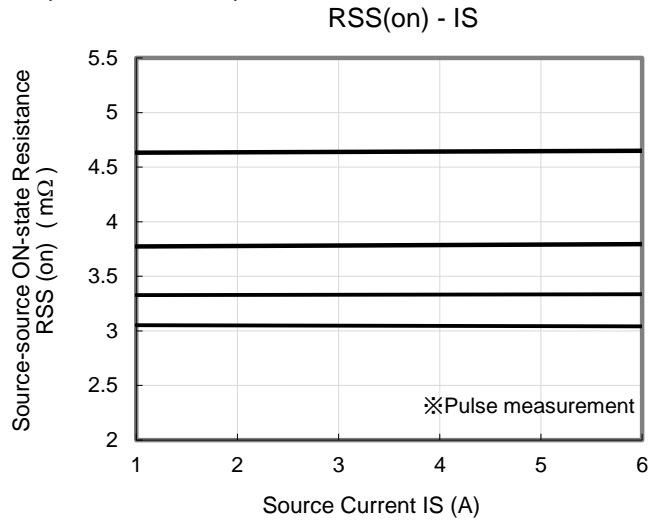
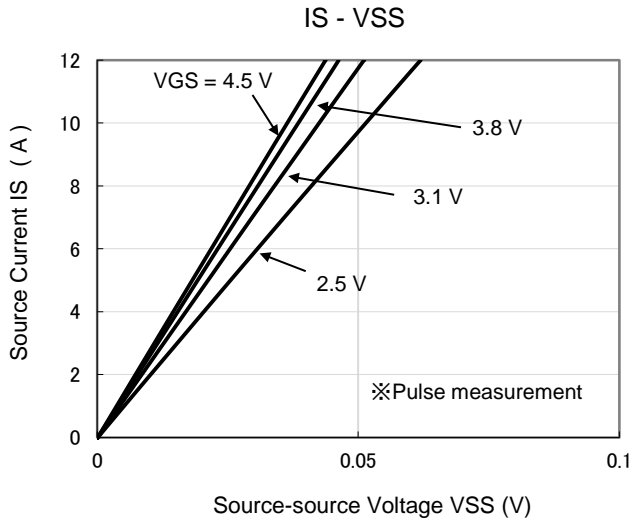



Technical Data (reference)

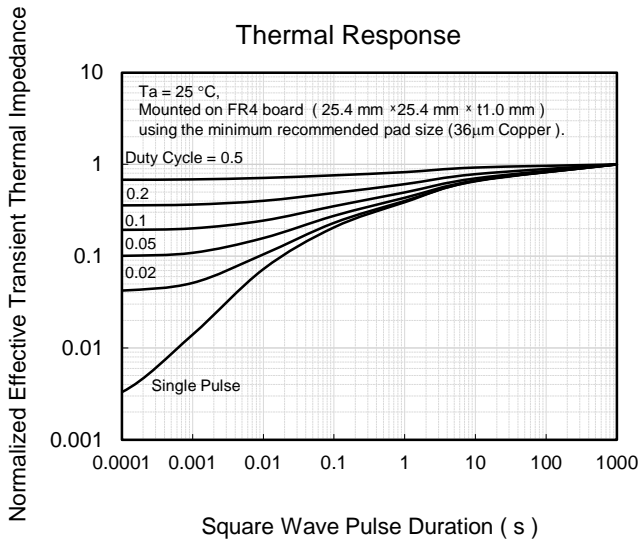
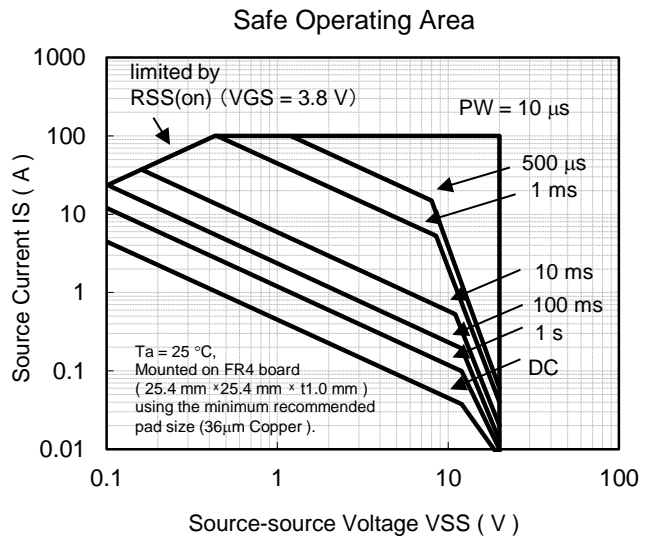
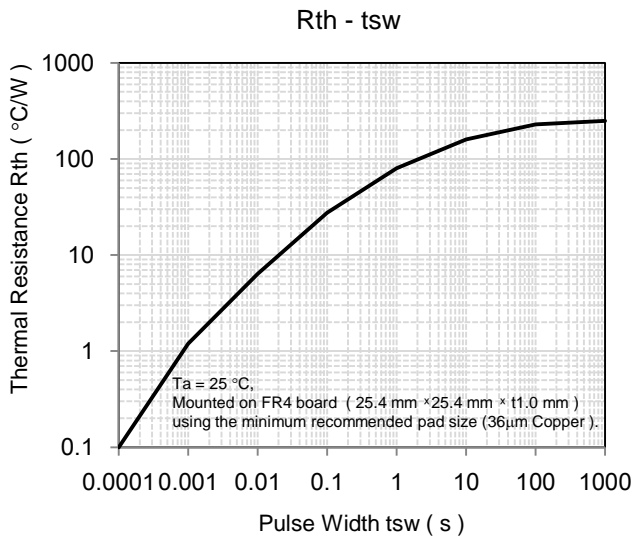
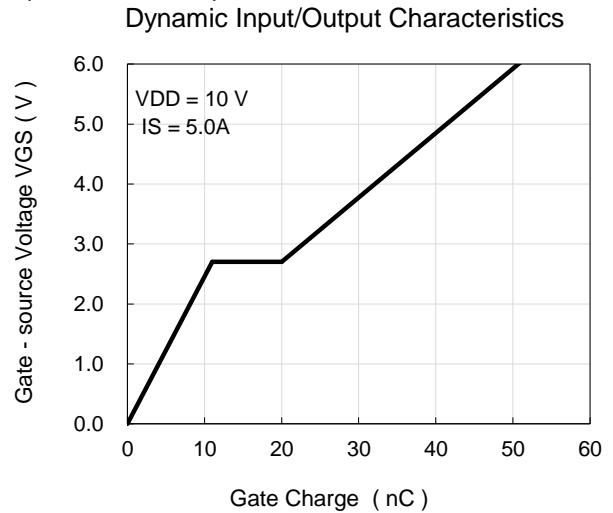
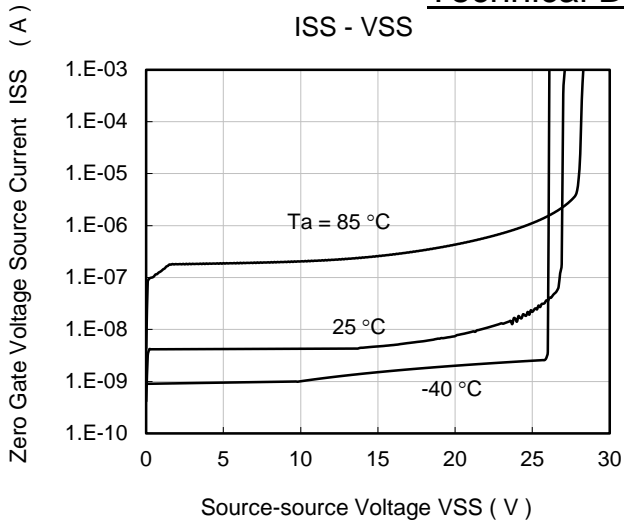

■ Outline (TCSP1831011-N1)

Unit: mm

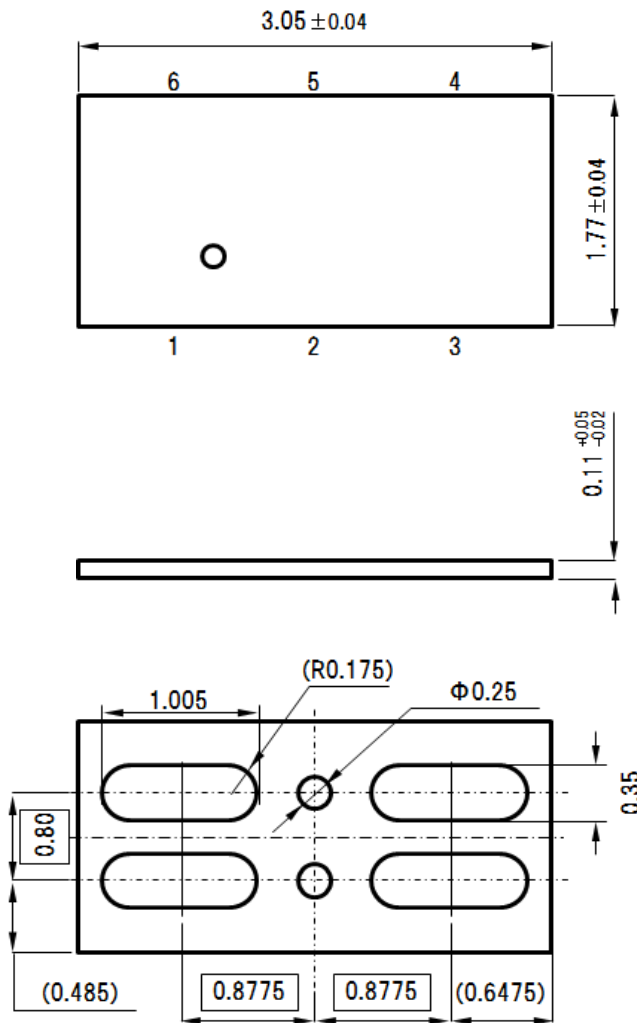

■ Land Pattern (Reference)

Unit: mm

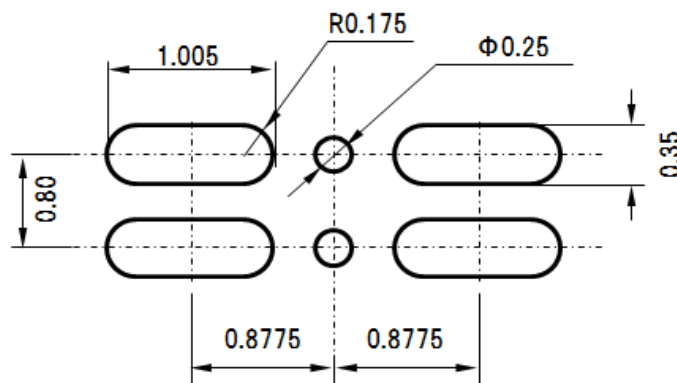

Request for your special attention and precautions in using the technical information and semiconductors described in this book

- (1) If any of the products or technical information described in this book is to be exported or provided to non-residents, the laws and regulations of the exporting country, especially, those with regard to security export control, must be observed.
- (2) The technical information described in this book is intended only to show the main characteristics and application circuit examples of the products. No license is granted in and to any intellectual property right or other right owned by Panasonic Corporation, Nuvoton Technology Corporation Japan or any other company. Therefore, no responsibility is assumed by our company as to the infringement upon any such right owned by any other company which may arise as a result of the use of technical information de-scribed in this book.
- (3) The products described in this book are intended to be used for general applications (such as office equipment, communications equipment, measuring instruments and household appliances), or for specific applications as expressly stated in this book.
Please consult with our sales staff in advance for information on the following applications, moreover please exchange documents separately on terms of use etc.: Special applications (such as for in-vehicle equipment, airplanes, aerospace, automotive equipment, traffic signaling equipment, combustion equipment, medical equipment and safety devices) in which exceptional quality and reliability are required, or if the failure or malfunction of the products may directly jeopardize life or harm the human body.
Unless exchanging documents on terms of use etc. in advance, it is to be understood that our company shall not be held responsible for any damage incurred as a result of or in connection with your using the products described in this book for any special application.
- (4) The products and product specifications described in this book are subject to change without notice for modification and/or improvement. At the final stage of your design, purchasing, or use of the products, therefore, ask for the most up-to-date Product Standards in advance to make sure that the latest specifications satisfy your requirements.
- (5) When designing your equipment, comply with the range of absolute maximum rating and the guaranteed operating conditions (operating power supply voltage and operating environment etc.). Especially, please be careful not to exceed the range of absolute maximum rating on the transient state, such as power-on, power-off and mode-switching. Otherwise, we will not be liable for any defect which may arise later in your equipment.
Even when the products are used within the guaranteed values, take into the consideration of incidence of break down and failure mode, possible to occur to semiconductor products. Measures on the systems such as redundant design, arresting the spread of fire or preventing glitch are recommended in order to prevent physical injury, fire, social damages, for example, by using the products.
- (6) Comply with the instructions for use in order to prevent breakdown and characteristics change due to external factors (ESD, EOS, thermal stress and mechanical stress) at the time of handling, mounting or at customer's process. We do not guarantee quality for disassembled products or the product re-mounted after removing from the mounting board.
When using products for which damp-proof packing is required, satisfy the conditions, such as shelf life and the elapsed time since first opening the packages.
- (7) When reselling products described in this book to other companies without our permission and receiving any claim of request from the resale destination, please understand that customers will bear the burden.
- (8) This book may be not reprinted or reproduced whether wholly or partially, without the prior written permission of our company.