

未量産品 / Under development
量産スケジュールについては当社にお問合せ下さい / Please consult Panasonic as for Mass production schedule.
As of April, 2020.

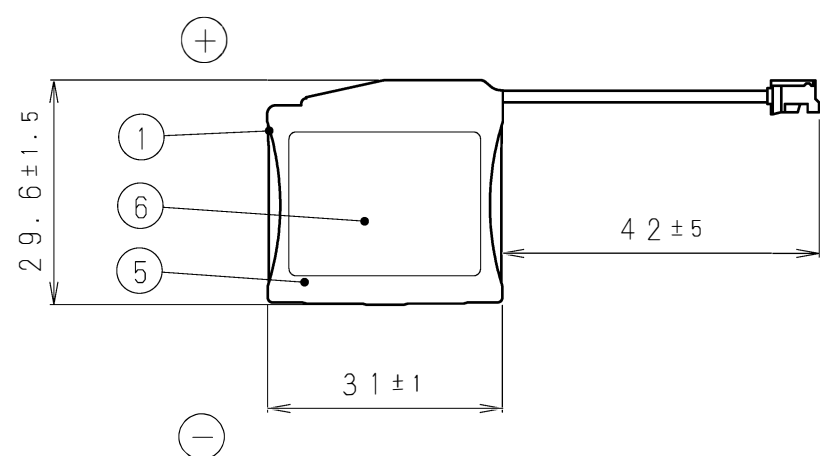

CIRCUIT DIAGRAM
 [回路図]

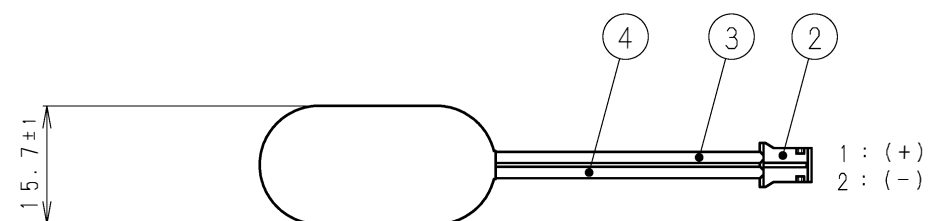
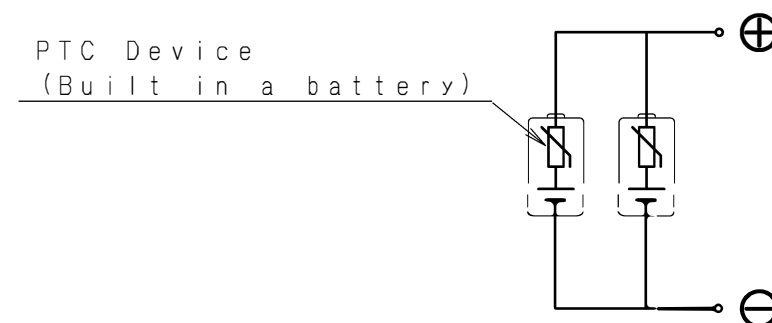

No	CONTENTS [内容]	
①	BATTERY [素電池]	CR-2Z : PANASONIC 2-BATTERIES PARALLEL
②	CONNECTOR	JST [日本圧着端子製造]
	HOUSING	PHR-2
	TERMINAL	SPH-002T-P0.5S : TIN PLATING [Snめっき]
③	(+) LEAD WIRE	UL AWM3385 AWG24 : RED
④	(-) LEAD WIRE	UL AWM3385 AWG24 : BLACK
⑤	OUTER TUBE [外装チューブ]	HEAT SHRINKABLE TUBE : YELLOW
⑥	LABEL	PET

NOTE [注記]
 1. NOMINAL VOLTAGE : 3V [公称電圧 : 3V]
 2. () : REFERENCE DIMENSION AND ANGLE [() 寸法、角度は参考値]

PRODUCT NO.	CR-2Zx2P (V)	SCALE
		1 : 1
DRAWING NO.	PC-CR-2Zx2P (V)	 UNIT : mm