

Detection range

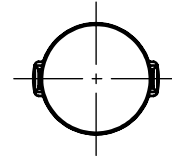

Recommended panel mouting hole dimensions

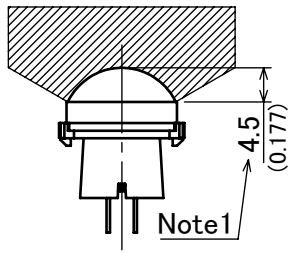
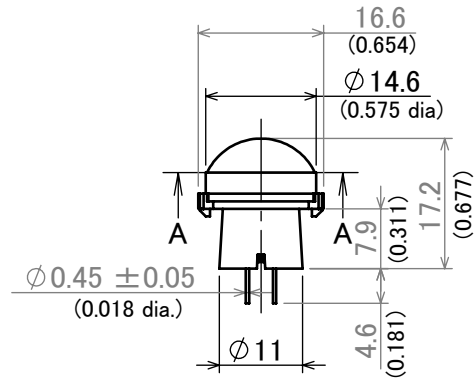
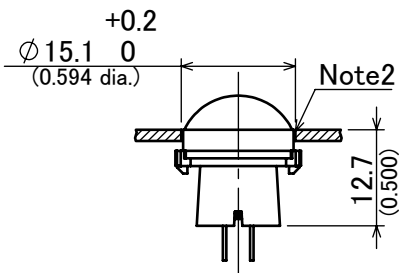

Recommended PC board pattern

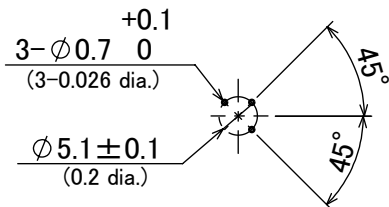

P.D.C. $\phi 5.08 \pm 0.2$
(0.2 dia.)

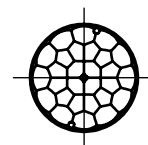
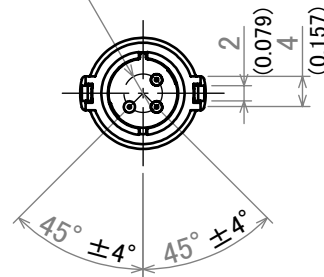

SECTION A-A

Note1 : In order to ensure proper detection, install it with the lens exposed at least 4.5mm (0.177inch)

Note2 : As for panel mouting hole, tapering or making a large size hole should be done.

General tolerance ± 0.5 mm
(± 0.020 inch)

Parts No. EKM***9111**

Date Nov.06.2017

Name PIR MOTION SENSOR 'PaPIRs' EKM series
(Slight motion detection type)

Scale 1:1

Unit mm

Tolerance

Panasonic Corporation
Eco Solutions Company