



Datasheet

6in1 Sensor: EWTS5G Series HP-Type

6DoF Inertial Sensor for Automotive

Overview

The 6in1 sensor is a 6DoF inertial sensor with functional safety standard ISO26262 compliance for automotive applications. The sensor consists of 3 acceleration and 3 rate sensing elements on a single MEMS chip. The MEMS, ASIC, and Cap are directly bonded at wafer level and packaged. This enables the 6in1 sensor to be compact, highly accurate, easy to install, and highly reliable.

Feature

- Functional Safety compliance (ISO26262) for automotive safety systems. Compatible with ASIL-D functional safety system development
- 6DoF sensors on one single MEMS chip with high accuracy for more system design flexibility
- Orthogonality: $\leq 0.01^\circ$ between Gyro and Acceleration axis. Enable compact and simple ECU system design
- 6in1 sensor package size: 4.5 x 4.5 x 1.1 mm
- RoHS compliance

- Adaptive cruise control (ACC)
- Adaptive front-lighting systems (AFS)
- Other safety chassis stability

Non-automotive application

- Motorcycle
- Agriculture or construction machine
- AGV or AMR and Forklift
- Industrial robot

Application

Automotive application

- Traction control systems (TCS)
- Electronic stability control (ESC)
- Roll stability control (RSC)
- Pitch stability control (PSC)
- Rollover airbag systems (ROS)

Typical Operating Circuit

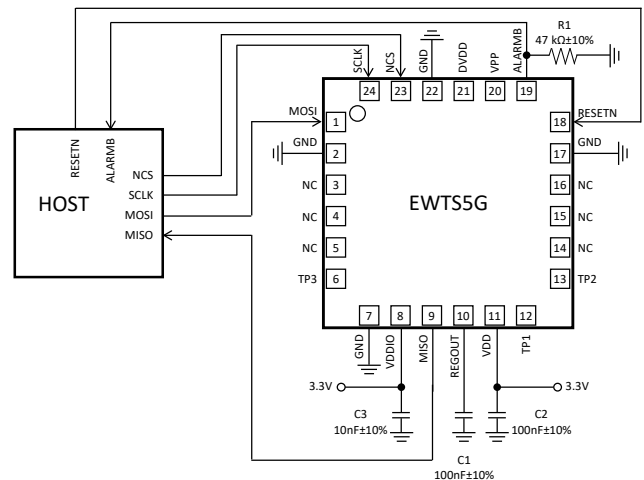

Table of Contents

1	Notice Items.....	3
2	Dimension Drawing And Measurement Direction.....	4
3	Environmental Conditions	5
4	Sensor Characteristics Specification	5
5	SPI Specification.....	9
6	Sample Source Code For A Quick Start.....	23
7	Pin Description.....	27
8	Interface Circuit	28
9	Recommended Pattern Layout.....	29
10	Notes For PCB Mounting	30
11	Handling Precautions.....	32
12	Reliability Test Items.....	33
13	Packaging Specification.....	34
14	Important Notice	37
15	Revision History	38

1 NOTICE ITEMS

1.1 THE APPLIED LAWS AND REGULATIONS

- 1) No ODCs or other ozone-depleting substances which are subject to regulation under the Montreal Protocol are used in our manufacturing processes
- 2) This product complies with the RoHS Directive (Restriction of the use of certain Hazardous Substances in electrical and electronic equipment (DIRECTIVE 2011/65/EU and (EU)2015/863).
- 3) All the materials used in this part are registered material under the "Law Concerning the Examination and Regulation of Manufactures etc. of Chemical substances".
- 4) If you need the notice by letter of "A preliminary judgment on the Laws of Japan foreign exchange and Foreign Trade control", please let us know.

2 DIMENSION DRAWING AND MEASUREMENT DIRECTION

2.1 DIMENSION DRAWING

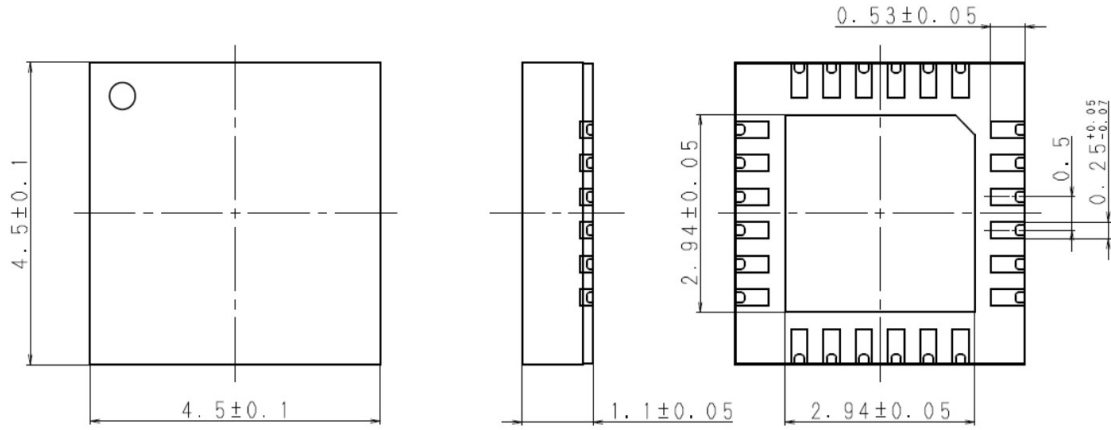

Figure 2-1 Dimension Drawing "Top View" (left) "Bottom View" (right)

2.2 MARKING INFORMATION

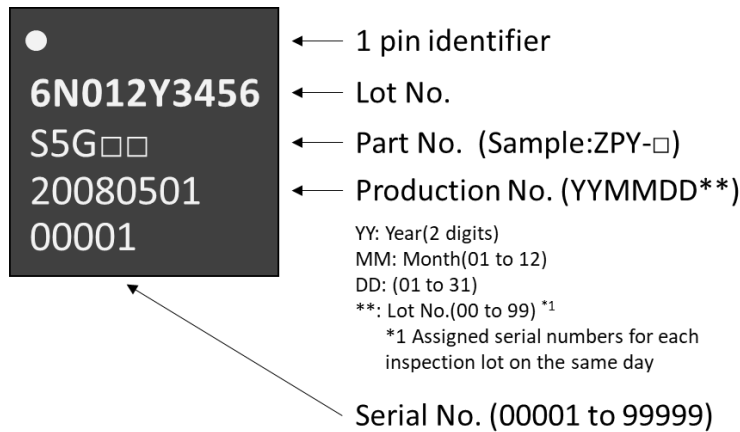

Figure 2-2 Marking Information

2.3 MEASUREMENT DIRECTION

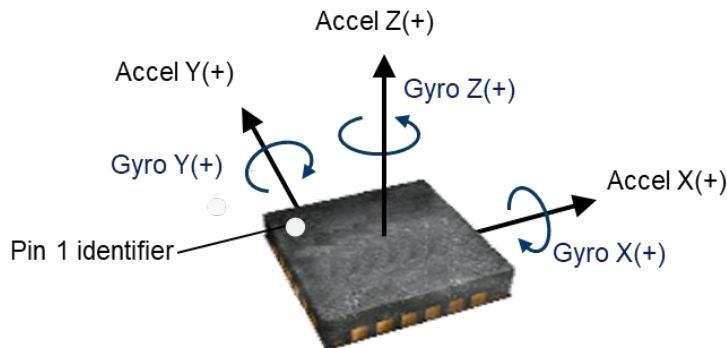

Figure 2-3 Measurement Direction

3 ENVIRONMENTAL CONDITIONS

Table 3-1 Environmental Conditions

No.	Item	Specification	Unit	Note
1	Maximum voltage rating	-0.3 to 6.5	V	VDD, VDDIO to GND
2	Operation Voltage	3.0 to 3.6	V	
3	Operating Temperature	-40 to +125	°C	
4	Storage Temperature	-40 to +125	°C	
5	Supply Current	≤10	mA	
6	Supply Ramp Time	0.01 to 700	ms	Monotonic ramp. Ramp rate is 10% to 90% of the final value.

4 SENSOR CHARACTERISTICS SPECIFICATION

VDD = 3.0 V to 3.6 V, Ta = -40degC to 125degC unless otherwise noted.

4.1 GYRO SENSOR

Table 4-1 Gyro Sensor Characteristics Specification

No.	Item	Condition	Specification			Unit	Note
			Min	Typ	Max		
1	Output Range			± 655		dps	±655/±327/±246/ ±122/±61 selectable
2	Guaranteed Measurement Range		-300		+300	dps	±300/±150/±120 ±60/±30 selectable
3	Sensitivity (Typ)			50		LSB/dps	50/100/133 /267/533 selectable
4	Sensitivity Error (Total)	Over life	-2.0		+2.0	%	
5	Linearity Error		-1.0		+1.0	%FS	*1
6	Offset Output (Typ)	Under stationary		0000h		LSB	2's complement
7	Offset Error (Total)	Over life	-2.0		+2.0	dps	*2
8	Output Noise				$0.1 \times \sqrt{\frac{\text{LPF Cutoff Freq.}}{60}}$	dps rms	"LPF Cutoff Freq." is defined in No.10
9	Cross-axis Sensitivity		-1.7		+1.7	%	
10	Start-up Time	Include self-test			0.25	s	
11	LPF Cutoff Frequency	-3dB Frequency		60		Hz	10/12.5/27/30/46/ 60Hz selectable

*1 FS means guaranteed measurement range (±300, ±150, ±120, ±60, or ±30dps).

*2 After being mounted and calibrated on the system side at rest.

4.2 ACCELERATION SENSOR

Table 4-2 Acceleration Sensor Characteristics Specification

No.	Item		Condition	Specification			Unit	Note
				Min	Typ	Max		
1	Output Range				±16		G	±32/±16/±4/±2 selectable
2	Guaranteed Measurement Range			-8		+8	G	±16/±8/±2/±1 selectable
3	Sensitivity (Typ)				2000		LSB/G	1000/2000/8000/16000 selectable
4	Sensitivity Error (Total)		Over life	-2.0		+2.0	%	
5	Linearity Error			-1.7		+1.7	%FS	*3
6	Offset Output (Typ)		Under stationary		0000h		LSB	2's complement
7	Offset Error (X/Y/Z axis)	Total	Over life	-0.05		+0.05	G	*4
8	Output Noise					$0.004 \times \sqrt{\frac{\text{LPF Cutoff Freq.}}{60}}$	G rms	"LPF Cutoff Freq." is defined in No.11
9	Cross-axis Sensitivity			-1.7		+1.7	%	
10	Start-up Time		Include self-test			0.25	s	
11	LPF Cutoff Frequency		-3dB Frequency		60		Hz	10/46/60/250/300/400Hz selectable

4.3 TEMPERATURE SENSOR

Table 4-3 Temperature Sensor Characteristics Specification

No.	Item		Condition	Specification			Unit	Note
				Min	Typ	Max		
1	Guaranteed Measurement Range			-40	-	+125	°C	
2	Output @25°C (Typ)			-	0000h	-	LSB	2's complement
3	Output Error (Total) @ 25°C		Over life	-10	-	+10	°C	
4	Sensitivity (Typ)			-	20	-	LSB/°C	
5	Sensitivity Error (Total)		Over life	-5	-	+5	%	
6	Linearity error			-2		+2	%FS	FS means 165°C (-40°C to 125°C)
7	Output Noise					0.5	°C rms	
8	Hysteresis		+25°C→+125°C→+25°C →-40°C→+25°C	-5		+5	°C	

*3 FS means guaranteed measurement range (±16, ±8, ±2, or ±1G).

*4 After being mounted and calibrated on the system side at rest.

4.4 FREQUENCY AFFECTING TO THE SENSOR

Table 4-4 Frequency Affecting To The Sensor

No.	Item	Condition	Specification			Unit	Note
			Min	Typ	Max		
1	Gyro X Axis Drive Frequency		26.4	-	29.4	kHz	MEMS resonant frequency
2	Gyro Y Axis Drive Frequency		24.4	-	27.5	kHz	MEMS resonant frequency
3	Gyro Z Axis Drive Frequency		27.8	-	32.2	kHz	MEMS resonant frequency
4	Gyro X Axis Sense Frequency		24.5	-	25.1	kHz	MEMS resonant frequency
5	Gyro Y Axis Sense Frequency		22.4	-	23.2	kHz	MEMS resonant frequency
6	Gyro Z Axis Sense Frequency		29.3	-	35.5	kHz	MEMS resonant frequency
7	Gyro X Axis Delta Frequency		1.9	-	4.3	kHz	MEMS resonant frequency
8	Gyro Y Axis Delta Frequency		2.0	-	4.3	kHz	MEMS resonant frequency
9	Gyro Z Axis Delta Frequency		1.5	-	3.3	kHz	MEMS resonant frequency
10	Acc X Axis 1st Mode Resonance Frequency		5.0	-	6.1	kHz	MEMS resonant frequency
11	Acc Y Axis 1st Mode Resonance Frequency		5.0	-	6.1	kHz	MEMS resonant frequency
12	Acc Z Axis 1st Mode Resonance Frequency		4.2	-	5.2	kHz	MEMS resonant frequency
13	SM1 Tone		0.62	0.75	0.88	kHz	Stimulus signal for SM
14	SM23 Tone1		1.75	1.8	1.85	kHz	Stimulus signal for SM
15	SM23 Tone2		6.11	6.3	6.49	kHz	Stimulus signal for SM

4.5 DEFINITION OF TERMS

4.5.1 Output range

An Output Range is the range that the one is given by data bit length (16 bit) divided by typical sensitivity.

4.5.2 Guaranteed Measurement Range

A Guaranteed measurement range is a measurement range that Panasonic guarantees by either design, characterization, production test or combination of some of them. However, the actual full-scale range that the sensor can detect and express in a 16-bit frame with 2's complement is wider than this guaranteed measurement range. This is because Panasonic needs to guarantee that the sensor output does not saturate, even including the sensitivity error and the offset error. For example, the gyro sensor's default guaranteed measurement range is $\pm 300\text{dps}$ while the full-scale range is $\pm 655\text{dps}$ ($2^{15}[\text{LSB}] / 50[\text{LSB}/\text{dps}]$). Relationships between input and output in default settings are shown in Figure 4-1.

Gyro sensor (FS: $\pm 300\text{dps}$)

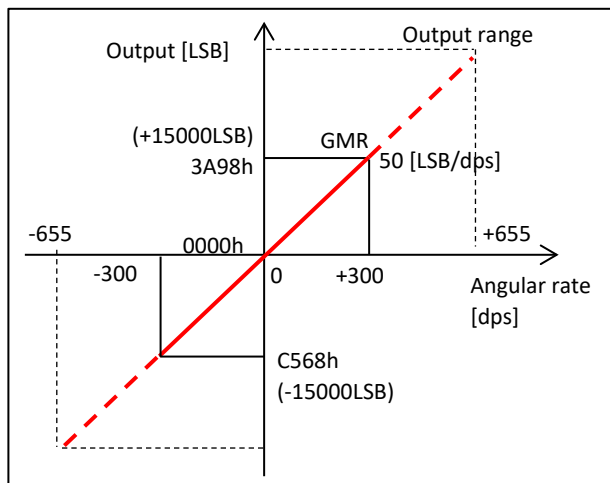

Acceleration sensor (FS: $\pm 8\text{G}$)

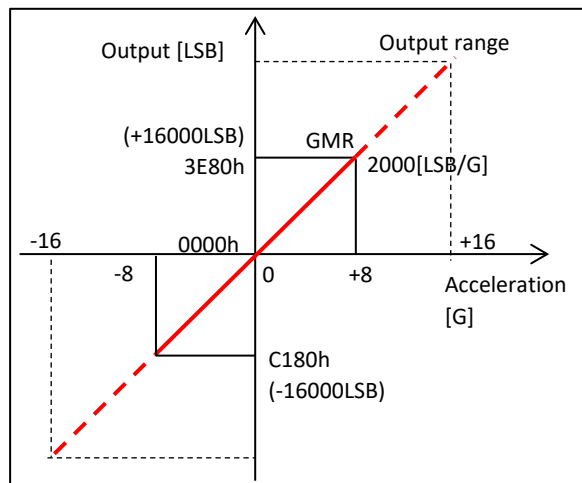

Temperature sensor

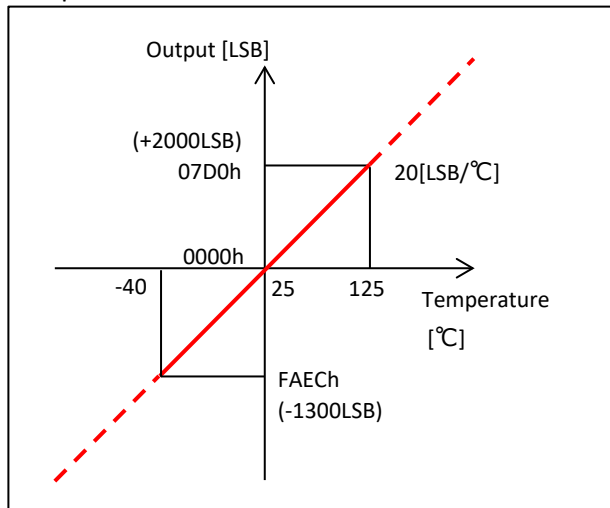

Note: Negative values are expressed in 2's complement.

- Output value: 0 to 32767 [LSB]
→ 0 to 32767 [LSB]
 - Output value: 32768 to 65535 [LSB]
→ Output value - 65536 [LSB]
- e.g. Output value = 32768 [LSB]
→ 32768 - 65536 = -32768 [LSB]
- Output value = 65535 [LSB]
→ 65535 - 65536 = -1 [LSB]

Figure 4-1 Relationships Between Input and Output in Default Settings

4.5.3 Start Up Time

Interval time from power-supply-on or hardware-reset until the startup self-test is finished and the sensor outputs get stabilized into the specified range. Please note that in case users need to configure some settings (for example low pass filter cutoff frequency, guaranteed measurement range, and etc.) of the 6in1 sensor by sending SPI commands, the users need to do these after waiting for this start-up time. In other words, the time for this manual sensor configuration change by users is not included in this start-up time.

5 SPI SPECIFICATION

The 6in1 sensor uses SPI (Serial Peripheral Interface) to communicate with the host processor.

5.1 SPI INTERFACE PIN DESCRIPTION

The internal registers and memory of the 6in1 sensor can be accessed using an SPI interface at 8MHz. SPI operates in four-wire mode.

Table 5-1 Serial Interface Pins Description

PIN NUMBER	PIN NAME	PIN DESCRIPTION
1	MOSI	Master Output Slave Input
9	MISO	Master Input Slave Output
23	NCS	Chip Select
24	SCLK	Serial Clock

5.2 SPI INTERFACE OPERATION

SPI is a 4-wire synchronous serial interface that uses two control lines and two data lines. The 6in1 sensor always operates as a slave device during standard master-slave SPI operation.

With respect to the master, MOSI, MISO, and SCLK are shared among the slave devices. Each SPI slave device requires its own Chip Select (NCS) line from the master.

NCS goes low (active) at the start of transmission and goes back high (inactive) at the end. Only one chip select line is active at any given time, ensuring that only one slave is selected at any given time. The CS lines of the non-selected slave devices are held high, causing their MISO lines to remain in a high-impedance state so that they do not interfere with any active devices.

SPI Operational Features

1. Data are delivered MSB first and LSB last
2. Data are latched on the rising edge of SCLK
3. Data should be transitioned on the falling edge of SCLK
4. The maximum frequency of SCLK is 8 MHz

SPI read and write operations are completed in 32 clock cycles.

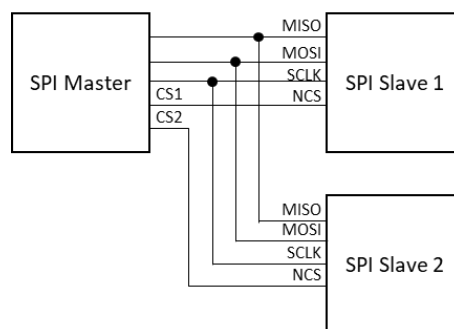

Figure 5-1 SPI Master/Slave Configuration

5.3 SPI INTERFACE CHARACTERISTICS

5.3.1 Digital Input Terminal Characteristics (SCLK, NCS, MOSI)

Table 5-2 SPI Digital Input Terminal Characteristics (SCLK, NCS, MOSI)

Items	Code	Min	Typ	Max	Unit	Note
Input Voltage (High)	VIH	0.7×VDDIO		VDDIO	V	
Input Voltage (Low)	VIL	0		0.3×VDDIO	V	
Leak Current	IIN:DIG	-10		10	μA	

5.3.2 Digital Output Terminal Characteristics (MISO)

Table 5-3 SPI Digital Output Terminal Characteristics (MISO)

Items	Code	Min	Typ	Max	Unit	Note
Output Voltage (High)	VOH	VDDIO-0.5		VDDIO	V	Isource = 1mA
Output Voltage (Low)	VOL	0		0.5	V	Isink = 1mA
Leak Current @Hi-Z	IIN:Hi-Z	-10		10	μA	

5.3.3 Reset Input Terminal Characteristics (RESETN)

Table 5-4 Reset Input Terminal Characteristics (RESETN)

Items	Code	Min	Typ	Max	Unit	Note
Input Voltage (High)	VIH	0.7 x VDDIO		VDDIO	V	
Input Voltage (Low)	VIL	0		0.3 x VDDIO	V	
Leak Current	IIN:DIG	-10		10	μA	
Reset Minimum Low Period	t _{RST}	10			ms	

5.3.4 Alarm Output Terminal Characteristics (ALARMB)

Table 5-5 Alarm Output Terminal Characteristics (ALARMB)

Items	Code	Min	Typ	Max	Unit	Note
Output Voltage (High)	VOH	VDDIO – 0.5		VDDIO	V	Source current = 1mA
Output Voltage (Low)	VOL	0		0.5	V	Sink current = 1mA

5.3.5 Timing Characteristics

Table 5-6 SPI Timing Characteristics

Items	Code	Min	Typ	Max	Unit	Note
SCLK Frequency	f_{SCLK}			8	MHz	
SCLK High Duration	t_{CLKH}	52.5			ns	
SCLK Low Duration	t_{CLKL}	52.5			ns	
SCLK Rise Time	t_{CLKR}			10	ns	
SCLK Fall Time	t_{CLKF}			10	ns	
NCS Setup Time	t_{CLKSU}	35			ns	For SCLK rising edge/falling edge *5
NCS Hold Time	t_{NCSHD}	25			ns	For SCLK rising edge/falling edge *6
NCS Minimum High Duration	t_{NCSH}	35			ns	
MOSI Setup Time	t_{MOSIS}	20			ns	
MOSI Hold Time	t_{MOSIH}	20			ns	
MISO Output Delay Time	t_{MISOEN}			100	ns	CL=30pF
MISO Data Access Time	t_{MISODA}			52	ns	CL=30pF
MISO Open Time	t_{MISODS}			44	ns	CL=30pF
SCLK Hold Time After Rising NCS	t_{CLKRH}	10			ns	
SCLK Hold Time Before Falling NCS	t_{CLKFH}	5			ns	

5.3.6 Timing Chart

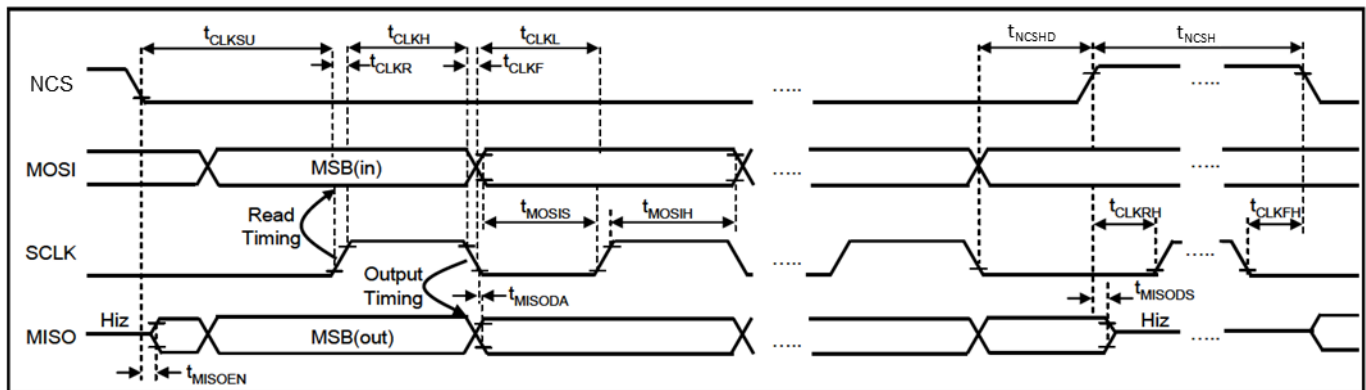

Figure 5-2 Timing Chart

*5 Do not operate SCLK during t_{CLKSU} after falling NCS. When NCS falls "Low", SCLK must be set "Low" previously.

*6 Do not operate SCLK during t_{NCSHD} before rising NCS. When NCS rises "High", SCLK must be set "Low" previously.

5.3.7 SPI Message Timing

The 6in1 sensor uses out-of-frame communication. The MISO responses are output in the next frame of the MOSI commands. Also, sensor internal register data is updated at the rising edges of NCS. Please note that the sensor internal ODR (Output Data Rate) is 8000 sample/s while SCLK frequency is 8MHz at maximum.

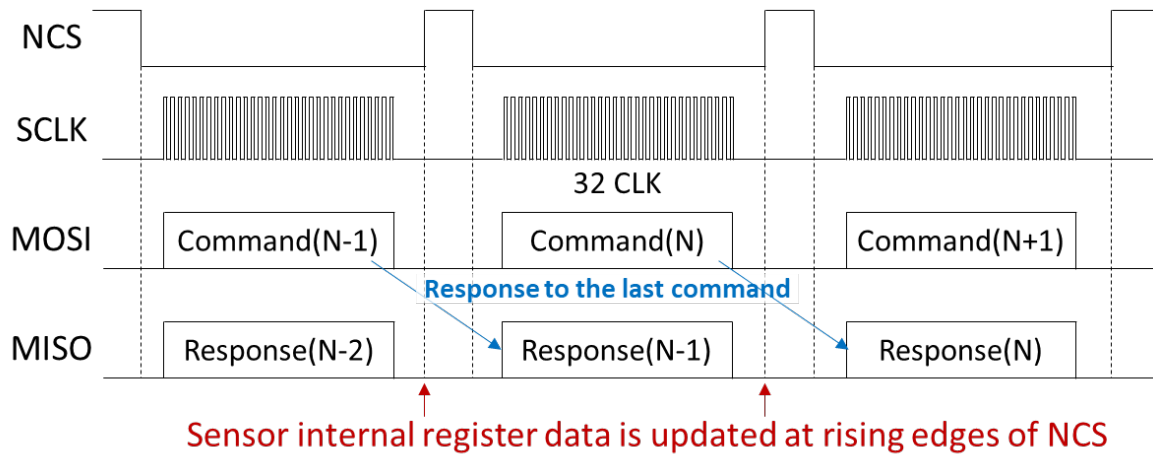

Figure 5-3 SPI Message Timing

5.4 SENSOR DATA ACQUISITION COMMANDS

The framework of sensor data acquisition commands is shown in Table 5-7. The b15 to b13 in MOSI should be b101 as to be in “Data Monitor Mode”. The b11 to b8 in MOSI should be chosen from Table 5-8 depending on the sensor data type. The b31 to b16 in MISO is the sensor data expressed in the 16-bit 2’s complement.

Table 5-7 The Framework Of Sensor Data Acquisition Commands (Data Monitor Mode)

	b31	b30	b29	b28	b27	b26	b25	b24	b23	b22	b21	b20	b19	b18	b17	b16	b15	b14	b13	b12	b11	b10	b09	b08	b07	b06	b05	b04	b03	b02	b01	b00
MOSI	[All 0]																SPI MODE			SADR				X2		CRC						
	0	0	0	0	0	0	0	0	0	0	0	0	0	0	0	0	1	0	1	0	0/1	0/1	0/1	0/1	0/1	0	0	0	0/1	0/1	0/1	0/1
MISO	Sensor Data																Common Error Flag			SADR				X2		KACT		CRC				
	0/1	0/1	0/1	0/1	0/1	0/1	0/1	0/1	0/1	0/1	0/1	0/1	0/1	0/1	0/1	0/1	0/1	0/1	0/1	1	0	0/1	0/1	0/1	0/1	0/1	0	0/1	0/1	0/1	0/1	0/1

Table 5-8 SADR in Data Monitor Mode

SADR				Sensor Data Type
b11	b10	b09	b08	
0	0	0	0	Gyro-X-axis
0	0	0	1	Reserved
0	0	1	0	Gyro-Y-axis
0	0	1	1	Reserved
0	1	0	0	Gyro-Z-axis
0	1	0	1	Reserved
0	1	1	0	Accel X-axis
0	1	1	1	Reserved

SADR				Sensor Data Type
b11	b10	b09	b08	
1	0	0	0	Accel Y-axis
1	0	0	1	Reserved
1	0	1	0	Accel Z-axis
1	0	1	1	Reserved
1	1	0	0	Temp 1
1	1	0	1	Temp-2
1	1	1	0	ΔT (=Temp1-Temp2)
1	1	1	1	Fixed value (AA55h)

5.4.1 Common Error Flag

The b15 to b14 in MISO is called as “Common Error Flag”. If the 6in1 sensor’s internal safety mechanisms detect any error, it becomes b01. When there is no alarm, it shows b10.

Table 5-9 The Meaning Of Common Error Flag (b15 to b14) Bits In Data Monitor Mode MISO

Common Error Flag		Function
b15	b14	
1	0	None of all safety mechanisms has an alarm
0	1	Any one of all safety mechanisms has an alarm

The host processor can read the same information through ALARMB terminal shown in Table 7-1 and Figure 8-1. ALARMB is active low, therefore the output becomes low when the common error flag becomes b01. Also, after the power-on-reset, the ALARMB becomes low from 11.5ms to 75.5ms and goes back to high, as part of the start-up self-test.

5.4.2 X2 Bit for Data Synchronization

The b07 is called as X2 bit. X2 bit is there to synchronize the sensor data update timing in all six axes. The meaning of the X2 bit is shown in Table 5-10.

Table 5-10 The Meaning Of X2 Bit In Data Monitor Mode

b07(X2 bit)	Function
0	New sensor data acquisition is suspended
1	Sensor data acquisition will restart at the NCS falling edge right after X2 is set to 1

For example, if the host processor is to use 6-axis data, all of them can be synchronized in the following way.

- STEP1 Send the Fixed Value command with X2 = 1 (MISO 0x00 0x00 0xAF 0x87)
- STEP2 Send the Gyro-X axis command with X2 = 0 (MISO 0x00 0x00 0xA0 0x00)
- STEP3 Send the Gyro-Y axis command with X2 = 0 (MISO 0x00 0x00 0xA2 0x02)
- STEP4 Send the Gyro-Z axis command with X2 = 0 (MISO 0x00 0x00 0xA4 0x04)
- STEP5 Send the Accel-X axis command with X2 = 0 (MISO 0x00 0x00 0xA6 0x06)
- STEP6 Send the Accel-Y axis command with X2 = 0 (MISO 0x00 0x00 0xA8 0x08)
- STEP7 Send the Accel-Z axis command with X2 = 0 (MISO 0x00 0x00 0xAA 0x0A)
- STEP8 Send the Fixed Value command with X2 = 0 (MISO 0x00 0x00 0xAF 0x0F)

Please note that X2 is set to 1 only in STEP1. At the NCS falling edge right after X2 is set to 1, new sensor data for all data types (Gyro X, Y, Z, Accel X, Y, Z, Temp1, Temp2, ΔT, and Fixed Value) are acquired and stored into the sensor internal registers. On the other hand, X2 is set to 0 after STEP1. Because of this, new sensor data will not be acquired inside of the sensor. However, the sensor data stored in the register can be retrieved through MISO one by one. Figure 5-4 shows the image of this example.

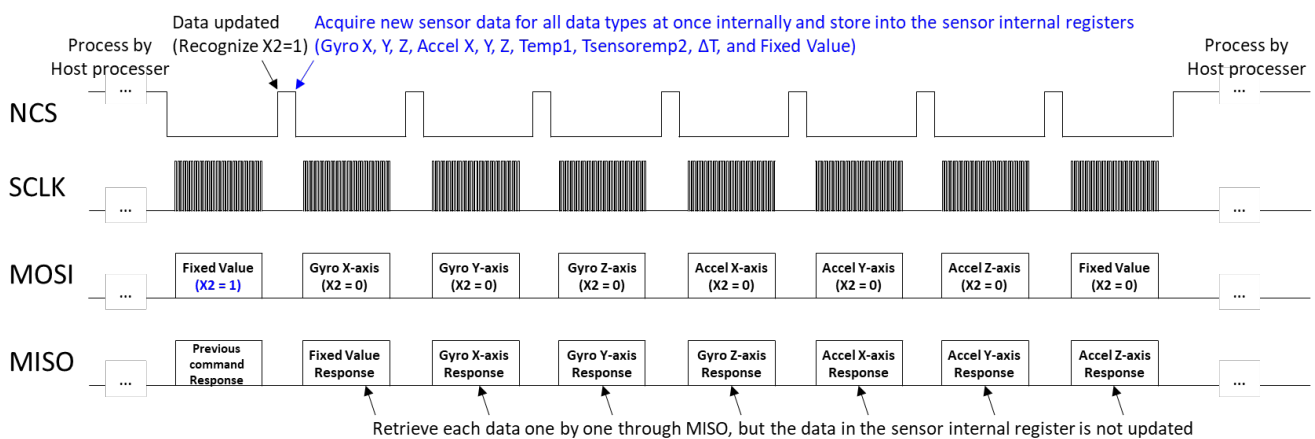

Figure 5-4 An Example Of Data Synchronization Using X2 Bit

5.4.3 KACT: 2-bit Counter

The b05 to b04 is called KACT (Keep Alive Counter). KACT is a 2-bit counter which increments every time sensor data is read. KACT increment in the up-counting order (i.e. 00 → 01 → 10 → 11 → 00 → ...). KACT increments regardless of the X2 bit setting. Also, the increment in KACT is shared with all sensor data types. KACT is only cleared by a reset or power down. Figure 5-5 shows an example of KACT counter. MOSI1, MOSI2, MOSI3, and MOSI4 mean the 1st, 2nd, 3rd, and 4th byte of MOSI each. MISO is the same as well. In Figure 5-5, each byte is expressed in decimal.

Sequence	MOSI (DEC)				MISO (DEC)				KACT		Sensor Data Type and X2
	MOSI1	MOSI2	MOSI3	MOSI4	MISO1	MISO2	MISO3	MISO4	b5	b4	
1	0	0	160	0	170	85	175	15	0	0	Note Gyro X-axis_X2=0_MOSI Gyro Y-axis_X2=0_MOSI Gyro Z-axis_X2=1_MOSI Accel. X-axis_X2=1_MOSI Accel. Y-axis_X2=0_MOSI Accel. Z-axis_X2=0_MOSI Temp 1_X2=0_MOSI Temp 2_X2=1_MOSI Δ T(=Temp1-Temp2)_X2=1_MOSI Fixed value (AA55h)_X2=0_MOSI
2	0	0	162	2	0	25	160	25	0	1	
3	0	0	164	140	255	254	162	33	1	0	
4	0	0	166	142	0	30	164	176	1	1	
5	0	0	168	8	255	252	166	141	0	0	
6	0	0	170	10	0	69	168	24	0	1	
7	0	0	172	12	7	185	106	33	1	0	
8	0	0	173	133	0	191	172	59	1	1	
9	0	0	174	134	0	213	173	141	0	0	
10	0	0	175	15	255	227	174	154	0	1	

Figure 5-5 An Example Of KACT Counter

5.4.4 CRC Calculation

The last four bits of the 32-bit communication protocol is CRC (Cyclic Redundancy Check) of the rest of the twenty-eight bits. Every time the host processor communicates through SPI, data integrity is checked using this CRC. The CRC is calculated in the following way.

CRC: X^4+1 (Width: 4bit, Polynomial: 0x1, Initial value: 0xA)

ex. If the transferred data is "0xD07A655*", the CRC calculation result is 0xC. (* is CRC section.) Therefore, send data is "0xD07A655C".

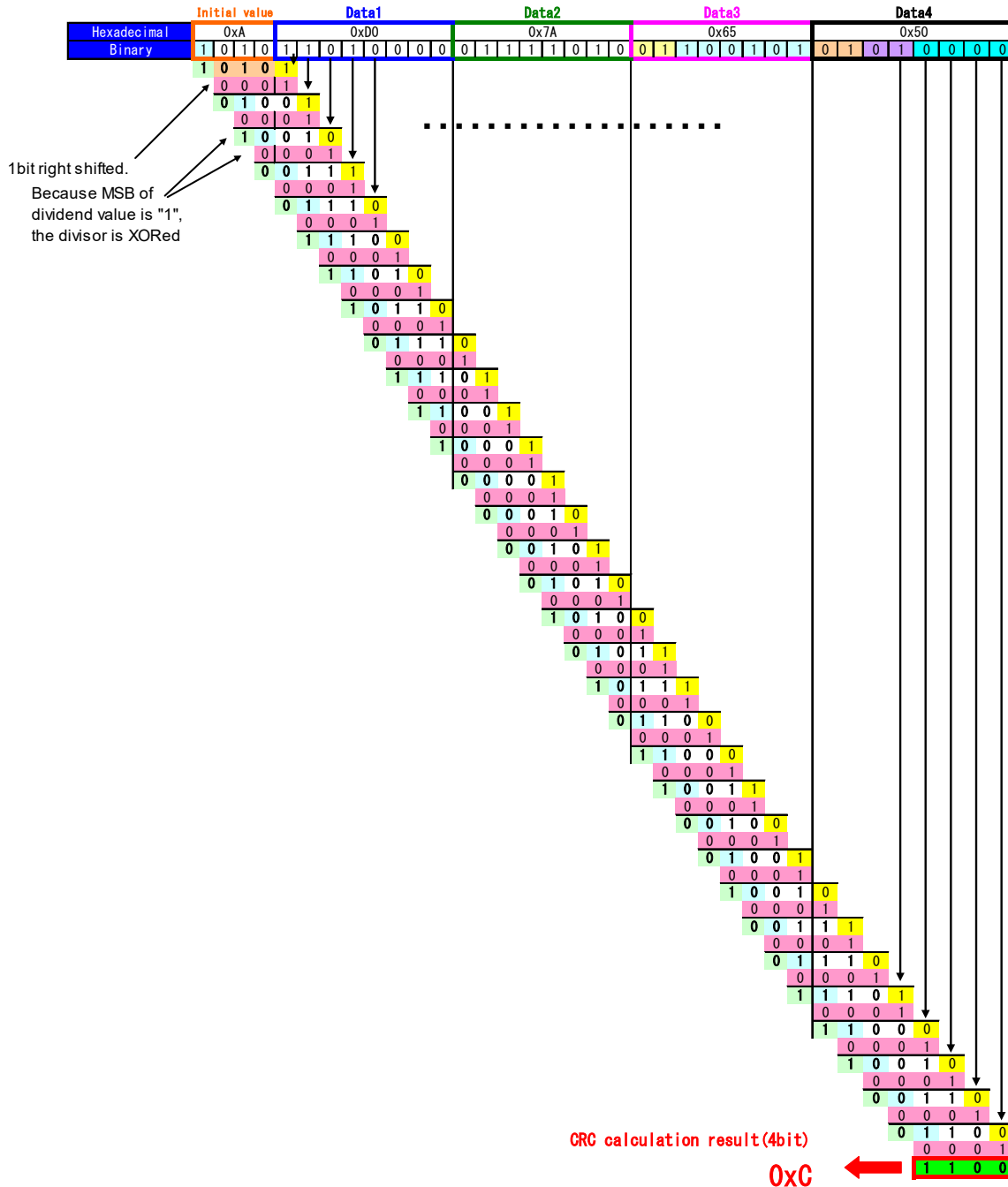

Figure 5-6 CRC Calculation

Also, a sample code of CRC calculation is shown in 6 Sample Source Code For A Quick Start.

5.5 ERROR MESSAGES

There are two types of error messages related to SPI communication, "SPI Error" and "Unrecognized Command Error". These error messages are issued when errors occurred at any time. The error messages will be notified through MISO in the next frame. Error messages are cleared by reset, power down, or the next successful SPI communication. Also, when these errors occurred, the commands in MOSI will be ignored.

5.5.1 SPI Error

The SPI error is issued when SPI communication fails. The SPI error message is "0x00000903". The bit arrangement is shown in Table 5-11. SPI error occurs under any one of the following conditions.

- The number of SCLK bit count is wrong (not equal to 32)
- The CRC in the MOSI command is wrong
- Error occurred in the command decoding

Table 5-11 SPI Error

	b31	b30	b29	b28	b27	b26	b25	b24	b23	b22	b21	b20	b19	b18	b17	b16	b15	b14	b13	b12	b11	b10	b09	b08	b07	b06	b05	b04	b03	b02	b01	b00	
MISO	0	0	0	0	0	0	0	0	0	0	0	0	0	0	0	0	0	0	0	0	1	0	0	1	0	0	0	0	0	0	0	0	CRC

Also, about the wrong SCLK bit count, the 6in1 sensor handles the following way.

- In case the clock edge count is less than 32, the MOSI keeps the last received bit level while the NCS is low
- In case the clock edge count is more than 32, the MOSI keeps a low level while the NCS is low.

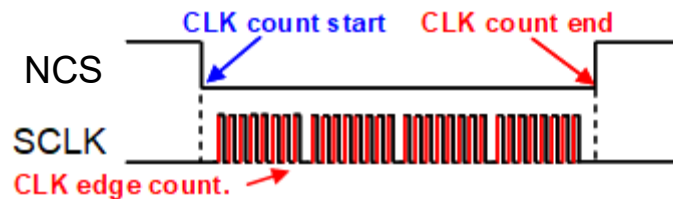

Figure 5-7 SCLK Bit Count Timing

5.5.2 Unrecognized Command Error

The unrecognized command error is issued when the MOSI receives undefined SPI command even though SPI communication itself is successful. The unrecognized command error message is "0x00000A00". The bit arrangement is shown in Table 5-12.

Table 5-12 Unrecognized Command Error

	b31	b30	b29	b28	b27	b26	b25	b24	b23	b22	b21	b20	b19	b18	b17	b16	b15	b14	b13	b12	b11	b10	b09	b08	b07	b06	b05	b04	b03	b02	b01	b00
MISO	0	0	0	0	0	0	0	0	0	0	0	0	0	0	0	0	0	0	0	0	1	0	1	0	0	0	0	0	0	0	0	CRC

5.6 HOW TO CHANGE THE GUARANTEED MEASUREMENT RANGE AND THE LPF CUTOFF FREQUENCY

If needed, the host processor can change the guaranteed measurement range and the LPF cutoff frequency by changing some register values. The gyro sensor's guaranteed measurement range is selectable from ± 300 , ± 150 , ± 120 , ± 60 , and ± 30 dps (the default setting is ± 300 dps). The acceleration sensor's guaranteed measurement range is selectable from ± 16 , ± 8 , ± 2 , and ± 1 G (the default setting is ± 8 G). The gyro sensor's LPF cutoff frequency is selectable from 10, 12.5, 27, 30, 46, and 60 Hz (the default setting is 60Hz). The acceleration sensor's LPF cutoff frequency is selectable from 10, 46, 60, 250, 300, and 400 Hz (the default setting is 60Hz). The host processor can change these settings with the following procedures. Please note that the register is a volatile memory, and the setting is to be reset to the default value after power-on-reset. Therefore, it is highly recommended to implement a power-on-reset detection mechanism in the system.

5.6.1 Flow Chart Of The Overall Procedure

Flow chart of the overall procedure is shown in Figure 5-8. After power-on, please wait for 250ms to complete the start-up. After this, please execute the LPF cutoff frequency change procedure or guaranteed measurement range change procedure if necessary.

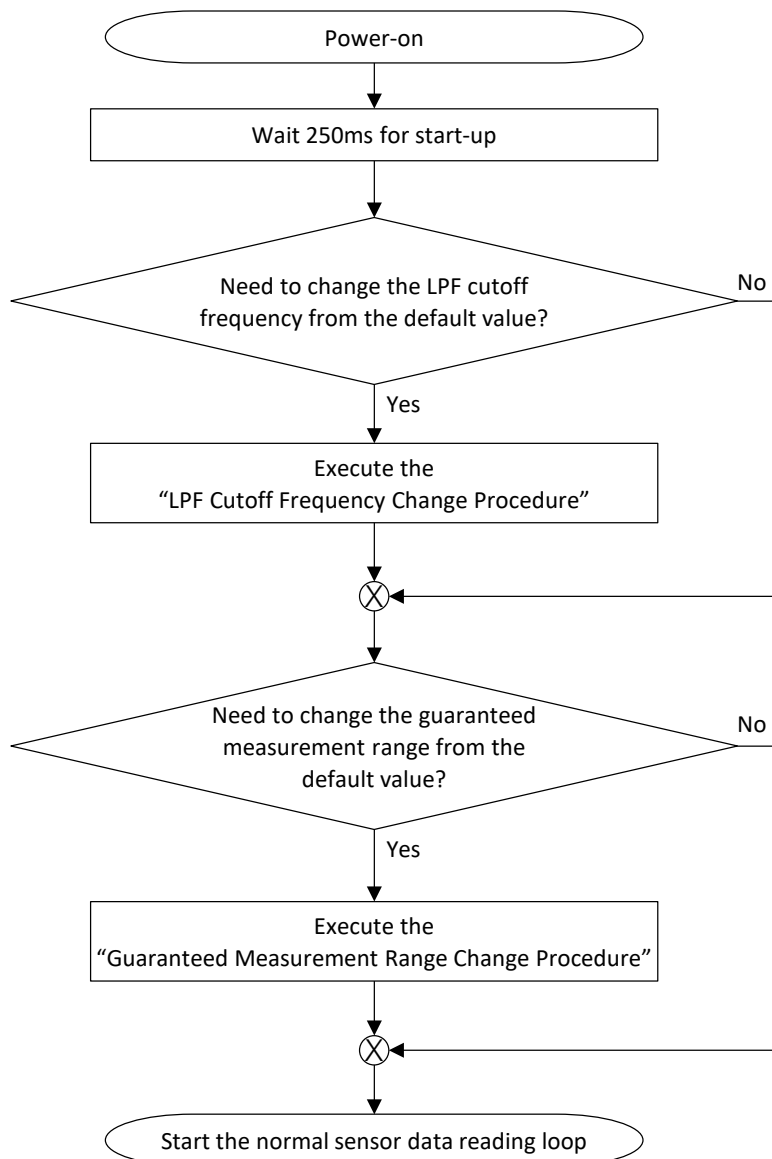

Figure 5-8 Flow Chart Of Overall Guaranteed Measurement Range And LPF Cutoff Frequency Change Procedure

5.6.2 LPF Cutoff Frequency Change Procedure

The flow chart of the LPF cutoff frequency change procedure is shown in Figure 5-9. The SPI command sequence STEP 1 to STEP 15 is shown in Table 5-13. In STEP 1 to STEP10, some bytes are varied depends on which LPF cutoff frequency setting the user chooses. Please refer to Table 5-14 to select the appropriate byte values.

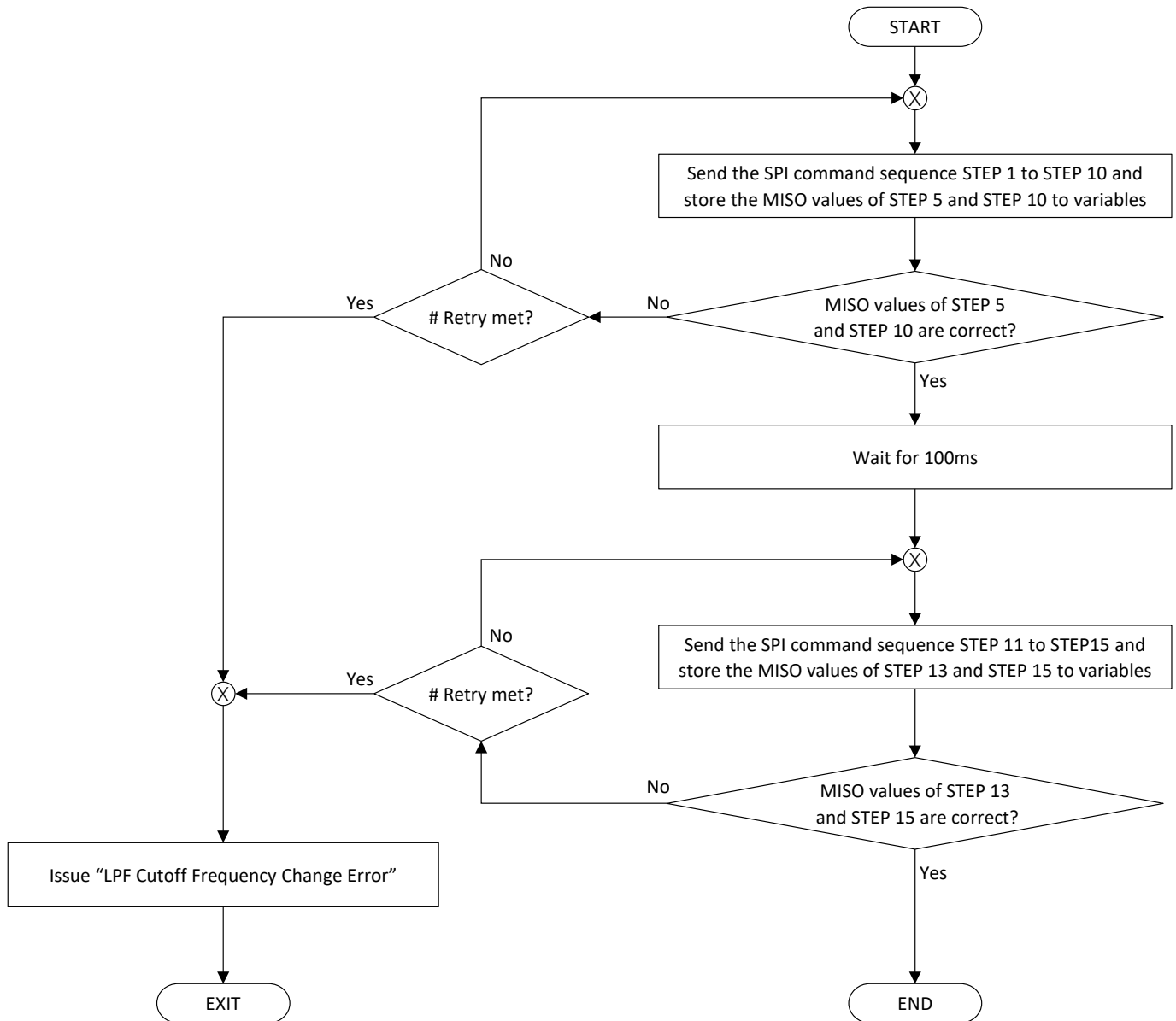

Figure 5-9 Flow Chart Of LPF Cutoff Frequency Change Procedure

Table 5-13 SPI Command Sequence To Change The LPF Cutoff Frequency

STEP	MOSI (HEX)				MISO (HEX)			
	STEP1	0x00	0x0C	0x32	0x43	Don't care		
STEP2	I	II	0x33	III	0x00	0x0C	0x32	0x43
STEP3	0x00	0x0C	0x32	0x43	I	II	0x33	III
STEP4	0x00	0x00	0x23	0x4F	0x00	0x0C	0x32	0x43
STEP5	0x00	0x00	0x23	0x4F	I	II	0x23	IV
STEP6	0x00	0x0E	0x32	0x41	Don't care			
STEP7	V	0x00	0x33	VI	0x00	0x0E	0x32	0x41
STEP8	0x00	0x0E	0x32	0x41	V	0x00	0x33	VI
STEP9	0x00	0x00	0x23	0x4F	0x00	0x0E	0x32	0x41
STEP10	0x00	0x00	0x23	0x4F	V	Don't care	0x23	Don't care
STEP11	0x00	0x00	0x2E	0xE8	Don't care			
STEP12	0x00	0x00	0x2E	0xE8	Don't care			
STEP13	0x00	0x00	0x2F	0xE9	0x00	0x00	0x2E	0xE8
STEP14	0x00	0x00	0x2F	0xE9	Don't care			
STEP15	0x00	0x00	0x2F	0xE9	0x00	0x00	0x2F	0xE9

← Needs to be checked

← Needs to be checked

← Needs to be checked

← Needs to be checked

Table 5-14 Individual Byte Values In The SPI Command Sequence To Change The LPF Cutoff Frequency

Gyro	Accel	I	II	III	IV	V	VI
10Hz	10Hz	0x00	0x41	0x4B	0x4A	0x01	0x4F
10Hz	46Hz	0x00	0x82	0x44	0x45	0x02	0x4C
10Hz	60Hz	0x00	0xC3	0x41	0x40	0x03	0x4D
10Hz	250Hz	0x01	0x04	0x4B	0x4A	0x04	0x4A
10Hz	300Hz	0x01	0x45	0x4E	0x4F	0x05	0x4B
10Hz	400Hz	0x01	0x86	0x41	0x40	0x06	0x48
12.5Hz	10Hz	0x01	0xC7	0x44	0x45	0x07	0x49
12.5Hz	46Hz	0x02	0x08	0x44	0x45	0x08	0x46
12.5Hz	60Hz	0x02	0x49	0x41	0x40	0x09	0x47
12.5Hz	250Hz	0x02	0x8A	0x4E	0x4F	0x0A	0x44
12.5Hz	300Hz	0x02	0xCB	0x4B	0x4A	0x0B	0x45
12.5Hz	400Hz	0x02	0x0C	0x41	0x40	0x0C	0x42
27Hz	10Hz	0x03	0x4D	0x44	0x45	0x0D	0x43
27Hz	46Hz	0x03	0x8E	0x4B	0x4A	0x0E	0x40
27Hz	60Hz	0x03	0xCF	0x4E	0x4F	0x0F	0x41
27Hz	250Hz	0x04	0xD3	0x44	0x45	0x13	0x4C
27Hz	300Hz	0x05	0x14	0x4E	0x4F	0x14	0x4B
27Hz	400Hz	0x05	0x55	0x4B	0x4A	0x15	0x4A
30Hz	10Hz	0x05	0x96	0x44	0x45	0x16	0x49
30Hz	46Hz	0x05	0xD7	0x41	0x40	0x17	0x48
30Hz	60Hz	0x06	0x18	0x41	0x40	0x18	0x47
30Hz	250Hz	0x06	0x59	0x44	0x45	0x19	0x46
30Hz	300Hz	0x06	0x9A	0x4B	0x4A	0x1A	0x45
30Hz	400Hz	0x06	0xDB	0x4E	0x4F	0x1B	0x44
46Hz	10Hz	0x07	0x1C	0x44	0x45	0x1C	0x43
46Hz	46Hz	0x07	0x5D	0x41	0x40	0x1D	0x42
46Hz	60Hz	0x07	0x9E	0x4E	0x4F	0x1E	0x41
46Hz	250Hz	0x07	0xDF	0x4B	0x4A	0x1F	0x40
46Hz	300Hz	0x08	0xE3	0x4B	0x4A	0x23	0x4F
46Hz	400Hz	0x09	0x24	0x41	0x40	0x24	0x48
60Hz	10Hz	0x04	0x92	0x41	0x40	0x12	0x4D
60Hz	46Hz	0x09	0xA6	0x4B	0x4A	0x26	0x4B
60Hz	60Hz	0x08	0x20	0x44	0x45	0x20	0x4C
60Hz	250Hz	0x0A	0x28	0x4E	0x4F	0x28	0x45
60Hz	300Hz	0x0A	0x69	0x4B	0x4A	0x29	0x45
60Hz	400Hz	0x0A	0xAA	0x44	0x45	0x2A	0x46

5.6.3 Guaranteed Measurement Range Change Procedure

The flow chart of the guaranteed measurement range change procedure is shown in Figure 5-10. The SPI command sequence STEP 1 to STEP 19 is shown in Table 5-15. In STEP 10 to STEP 19, some bytes are varied depends on which guaranteed measurement range setting the user chooses. Please refer to Table 5-16 to select the appropriate byte values.

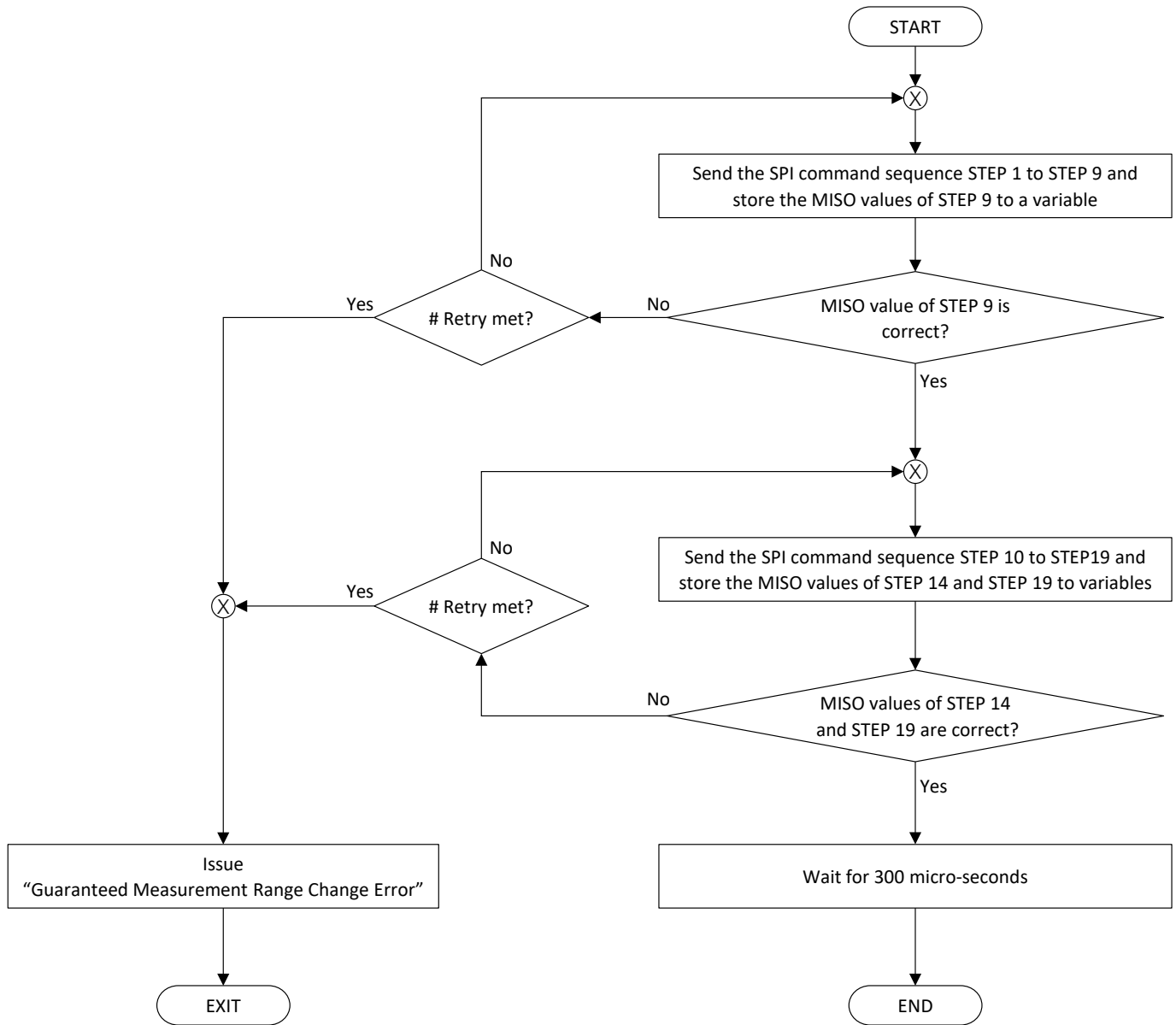

Figure 5-10 Flow Chart Of Guaranteed Measurement Range Change Procedure

Table 5-15 SPI Command Sequence To Change The Guaranteed Measurement Range

STEP	MOSI (HEX)				MISO (HEX)			
	STEP1	0x00	0x19	0x32	0x47	Don't care		
STEP2	0x03	0x02	0x33	0x4F	0x00	0x19	0x32	0x47
STEP3	0x00	0x19	0x32	0x47	0x03	0x02	0x33	0x4F
STEP4	0x01	0x81	0x33	0x46	0x00	0x19	0x32	0x47
STEP5	0x00	0x19	0x32	0x47	0x01	0x81	0x33	0x46
STEP6	0x02	0x84	0x33	0x40	0x00	0x19	0x32	0x47
STEP7	0x00	0x19	0x32	0x47	0x02	0x84	0x33	0x40
STEP8	0x00	0x00	0x23	0x4F	0x00	0x19	0x32	0x47
STEP9	0x00	0x00	0x23	0x4F	0x03	0x87	0x23	0x43
STEP10	0x00	0xF4	0x32	0x44	Don't care			
STEP11	0x00	I	0x33	II	0x00	0xF4	0x32	0x44
STEP12	0x00	0xF4	0x32	0x44	0x00	I	0x33	II
STEP13	0x00	0x00	0x23	0x4F	0x00	0xF4	0x32	0x44
STEP14	0x00	0x00	0x23	0x4F	0x00	I	0x23	III
STEP15	0x00	0xD4	0x32	0x46	Don't care			
STEP16	0x00	IV	0x33	V	0x00	0xD4	0x32	0x46
STEP17	0x00	0xD4	0x32	0x46	0x00	IV	0x33	V
STEP18	0x00	0x00	0x23	0x4F	0x00	0xD4	0x32	0x46
STEP19	0x00	0x00	0x23	0x4F	0x00	IV	0x23	VI

← Needs to be checked (rows 9, 14, 19)

Table 5-16 Individual Byte Values In The SPI Command Sequence To Change The Guaranteed Measurement Range

	Guaranteed Measurement Range	Sensitivity	I	II	III	IV	V	VI
Gyro	±300 deg/s	50 LSB/deg/s	0x01	0x4F	0x4E	-	-	-
	±150 deg/s	100 LSB/deg/s	0x00	0x4E	0x4F	-	-	-
	±120 deg/s	133 LSB/deg/s	0x0A	0x44	0x45	-	-	-
	±60 deg/s	267 LSB/deg/s	0x09	0x47	0x46	-	-	-
	±30 deg/s	533 LSB/deg/s	0x08	0x46	0x47	-	-	-
Accel.	±16 G	1000 LSB/G	-	-	-	0x03	0x4D	0x4C
	±8 G	2000 LSB/G	-	-	-	0x01	0x4F	0x4E
	±2 G	8000 LSB/G	-	-	-	0x07	0x49	0x48
	±1 G	16000 LSB/G	-	-	-	0x05	0x4B	0x4A

6 SAMPLE SOURCE CODE FOR A QUICK START

Below is a sample source code for a quick start that users can modify and use.

```

uint8_t ReceiveData[4];           // Array of MISO received
int data[6];                     // Array of sensor data for 6 axis
int error_flag;                  // Variable to store error flag

int main (void) {
    SPI_Init();                  // Please write appropriate code depending on the development environment
                                // Main SPI parameters are MSB First, SPI mode 0 (CPOL=0, CPHA=0) and SCLK=8MHz

    delay(250);                  // Wait 250ms for the start-up

    configure_the_sensor_setting(); // Change the LPF cutoff frequency and the Guaranteed Measurement Range

    while(1)
    {
        spi_command(0x00,0x00,0xAF,0x87); // Send the Fixed Value command (X2 = 1)
        spi_command(0x00,0x00,0xA0,0x00); //GyroX_MOSI (X2=0)
        spi_command(0x00,0x00,0xA2,0x02); //GyroY_MOSI (X2=0)
        data[0]=get_data();             //GyroX_MISO
        spi_command(0x00,0x00,0xA4,0x04); //GyroZ_MOSI (X2=0)
        data[1]=get_data();             //GyroY_MISO
        spi_command(0x00,0x00,0xA6,0x06); //AccelX_MOSI (X2=0)
        data[2]=get_data();             //GyroZ_MISO
        spi_command(0x00,0x00,0xA8,0x08); //AccelY_MOSI (X2=0)
        data[3]=get_data();             //AccelX_MISO
        spi_command(0x00,0x00,0xAA,0x0A); //AccelZ_MOSI (X2=0)
        data[4]=get_data();             //AccelY_MISO
        spi_command(0x00,0x00,0xAF,0x0F); //Send the Fixed Value command as a dummy command (X2=0)
        data[5]=get_data();             //AccelZ_MISO

        for (int i=0;i<6;i++) {
            print(data[i]);             // Output sensor data of each axis.
        }                               // Please use an appropriate print function depending on the development environment

        get_error_flag();               // Get the error flag
        print(error_flag);               // Output the error flag.
    }
}

//Define format for receiving 4 byte MISO
void spi_command(int byte1, int byte2, int byte3, int byte4){
    digitalWrite(SS, LOW);             // Start SPI communication
    ReceiveData[0]=SPITransfer(byte1); // 1st byte. Use an appropriate function depending on the development environment
    ReceiveData[1]=SPITransfer(byte2); // 2st byte
    ReceiveData[2]=SPITransfer(byte3); // 3st byte
    ReceiveData[3]=SPITransfer(byte4); // 4st byte
    digitalWrite(SS, HIGH);            // End SPI communication
}

```

```
int get_data()
int data_temp = ReceiveData[0] << 8 | ReceiveData[1]; // Choose 2 byte(1st & 2nd byte)
if (data_temp > 32767) { // When the most significant bit is 1
    data_temp = data_temp - 65536; // Calculate two's complement
}
return data_temp; // Return sensor data
}

int get_error_flag(){
int flag_temp = ReceiveData[2] >> 6; // Extract the common error flag
if (flag_temp == 1){ // If the common error flag is b01, it means error.
    error_flag = 1;
}
else if (flag_temp == 2){ // If the common error flag is b10, it means no error.
    error_flag = 0;
}
return error_flag; // Return error flag data
}
```



```

void configure_the_sensor_setting(){
    LPF_cutoff_frequency_change_procedure();           // LPF Cutoff Frequency Change
    guaranteed_measurement_range_change_procedure(); // Guaranteed Measurement Range Change
}

void LPF_cutoff_frequency_change_procedure(){
    int var[7] = {0x00,0x41,0x4B,0x4A,0x01,0x4F,0x43}; // Example of Gyro 10Hz, Accel 10Hz. Refer to Table 5-14 for other settings.
    spi_command(0x00,0x0C,0x32,0x43);                // STEP1
    spi_command(var[0],var[1],0x33,var[2]);           // STEP2
    spi_command(0x00 ,0x0C ,0x32,0x43);              // STEP3
    spi_command(0x00 ,0x00 ,0x23 ,0x4F);             // STEP4
    spi_command(0x00 ,0x00 ,0x23 ,0x4F);             // STEP5

    spi_command(0x00 ,0x0E ,0x32 ,0x41);              // STEP6
    spi_command(var[4] ,0x00 ,0x33 ,var[5]);          // STEP7
    spi_command(0x00 ,0x0E ,0x32 ,0x41);              // STEP8
    spi_command(0x00 ,0x00 ,0x23 ,0x4F);             // STEP9
    spi_command(0x00 ,0x00 ,0x23 ,0x4F);             // STEP10

    delay(100);                                       // Wait 100ms

    spi_command(0x00,0x00,0x2E,0xE8);                // STEP11
    spi_command(0x00,0x00,0x2E,0xE8);                // STEP12
    spi_command(0x00,0x00,0x2F,0xE9);                // STEP13
    spi_command(0x00,0x00,0x2F,0xE9);                // STEP14
    spi_command(0x00,0x00,0x2F,0xE9);                // STEP15
}

void guaranteed_measurement_range_change_procedure(){
    int var[6] = {0x08,0x46,0x47,0x05,0x4B,0x4A }; // Example of Gyro +-30dps Accel +-1G. Refer to Table 5-16 for other settings.

    spi_command(0x00,0x19,0x32,0x47);                // STEP1
    spi_command(0x03,0x02,0x33,0x4F);                // STEP2
    spi_command(0x00,0x19,0x32,0x47);                // STEP3
    spi_command(0x01,0x81,0x33,0x46);                // STEP4
    spi_command(0x00,0x19,0x32,0x47);                // STEP5
    spi_command(0x02,0x84,0x33,0x40);                // STEP6
    spi_command(0x00,0x19,0x32,0x47);                // STEP7
    spi_command(0x00,0x00,0x23,0x4F);                // STEP8
    spi_command(0x00,0x00,0x23,0x4F);                // STEP9

    spi_command(0x00,0xF4,0x32,0x44);                // STEP10
    spi_command(0x00,var[0],0x33,var[1]);             // STEP11
    spi_command(0x00,0xF4,0x32,0x44);                // STEP12
    spi_command(0x00,0x00,0x23,0x4F);                // STEP13
    spi_command(0x00,0x00,0x23,0x4F);                // STEP14
    spi_command(0x00,0xD4,0x32,0x46);                // STEP15
    spi_command(0x00, var[3],0x33,var[4]);           // STEP16
    spi_command(0x00,0xD4,0x32,0x46);                // STEP17
    spi_command(0x00,0x00,0x23,0x4F);                // STEP18
    spi_command(0x00,0x00,0x23,0x4F);                // STEP19

    delay_micros(300);                                // Wait more than 300 micro seconds. Use an appropriate delay function.
}

```

```
uint8_t CRC_calculation(uint8_t data1, uint8_t data2, uint8_t data3, uint8_t data4)
```

```
/* The arguments data1, data2, data3 and data4 can be 0xD0, 0x7A, 0x65, and 0x5* each for example. "*" in data4 can be any numbers */  
{
```

```
    int initial = 0xA;  
    int mask = 0x0F;  
    uint8_t crc;  
    int i;  
    int temp;  
    data4 = data4 & 0xF0;
```

```
    temp = initial << 8 | data1;  
    for (i = 0; i < 8; i++) {  
        if (((temp >> (11 - i)) & 1) == 1) {  
            temp = temp ^ (0x1 << (7 - i));  
        }  
    }
```

```
    temp = (temp & mask) << 8 | data2;  
    for (i = 0; i < 8; i++) {  
        if (((temp >> (11 - i)) & 1) == 1) {  
            temp = temp ^ (0x1 << (7 - i));  
        }  
    }
```

```
    temp = (temp & mask) << 8 | data3;  
    for (i = 0; i < 8; i++) {  
        if (((temp >> (11 - i)) & 1) == 1) {  
            temp = temp ^ (0x1 << (7 - i));  
        }  
    }
```

```
    temp = (temp & mask) << 8 | data4;  
    for (i = 0; i < 8; i++) {  
        if (((temp >> (11 - i)) & 1) == 1) {  
            temp = temp ^ (0x1 << (7 - i));  
        }  
    }
```

```
    crc = temp & mask; //CRC
```

```
    return crc;
```

```
}
```

7 PIN DESCRIPTION

Table 7-1 Pin Description

Pin No.	Pin Name	Description
1	MOSI	SPI data input
2	GND3	Ground supply
3, 4, 5	NC	Pins are internally connected to the central E-pad. Leave floating
6	TP3	Only for factory use. Leave floating
7	GND	Ground supply
8	VDDIO	IO power supply
9	MISO	SPI data output
10	REGOUT	Regulator (AVDD 1.8V) output
11	VDD	Core power supply
12	TP1	Only for factory use. Leave floating
13	TP2	Only for factory use. Leave floating
14, 15, 16	NC	Pins are internally connected to the central E-pad. Leave floating
17	GND4	Ground supply
18	RESETN	Hardware reset pin (Active low. Internally pulled up to the VDDIO)
19	ALARMB	Alarm output (Active low. Replication of internal common error flag)
20	VPP	Only for factory use. Leave floating
21	DVDD	Regulator (DVDD 1.8V) output, kept open by a CMOS switch. Leave floating
22	GND2	Ground supply
23	NCS	SPI chip select input (Internally pulled up to the VDDIO)
24	SCLK	SPI clock input

8 INTERFACE CIRCUIT

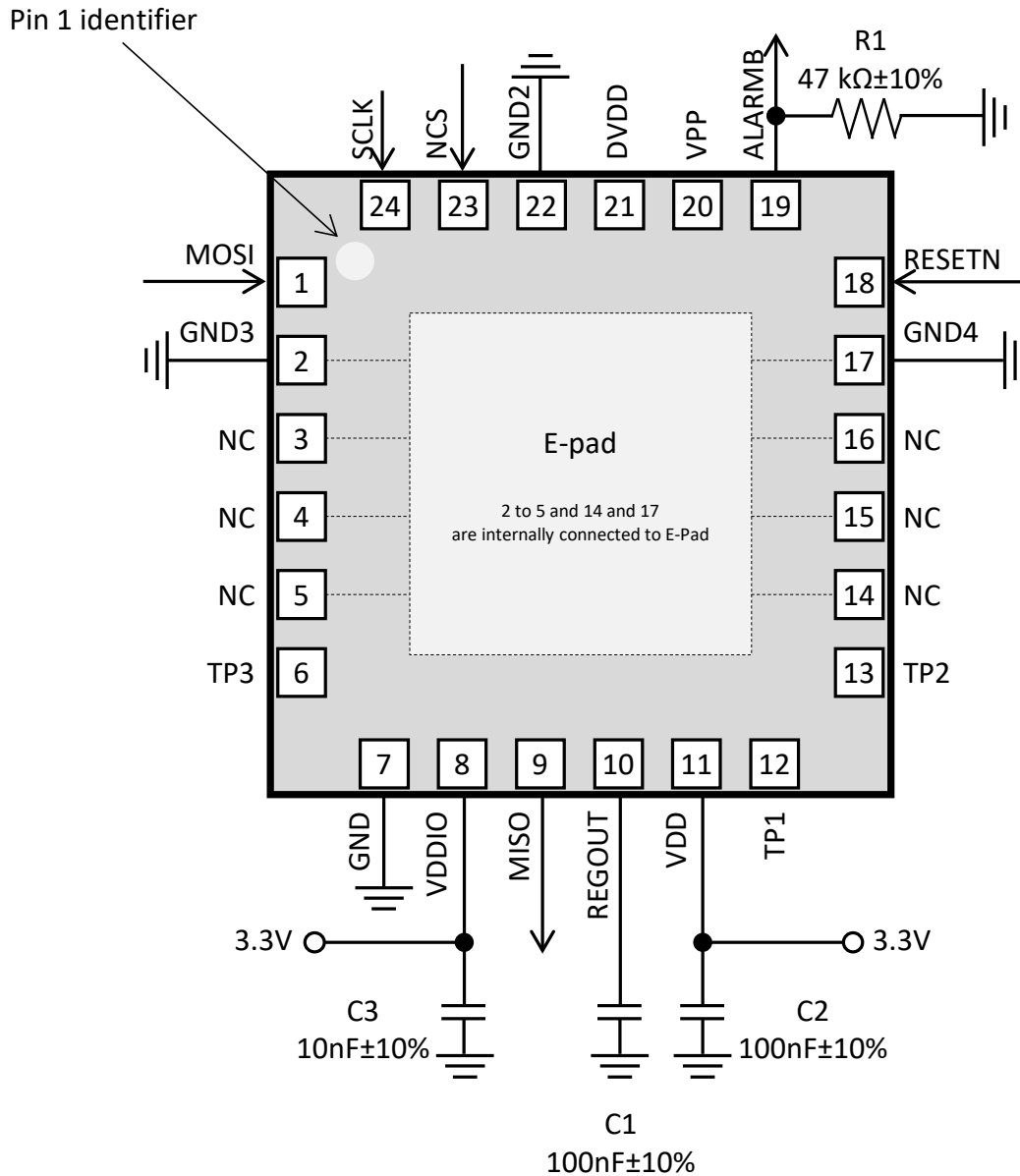

Figure 8-1 Interface Circuit (Top view)

Table 8-1 External Component List

Component	Label	Specification
REGOUT Capacitor	C1	100nF ±10%
VDD Bypass Capacitor	C2	100nF ±10%
VDDIO Bypass Capacitor	C3	10nF ±10%
ALARMB Pull-down resistor	R1	47kΩ ±10%

9 RECOMMENDED PATTERN LAYOUT

Please also refer to the 10 Notes For PCB Mounting.

Terminal (Unit: mm)

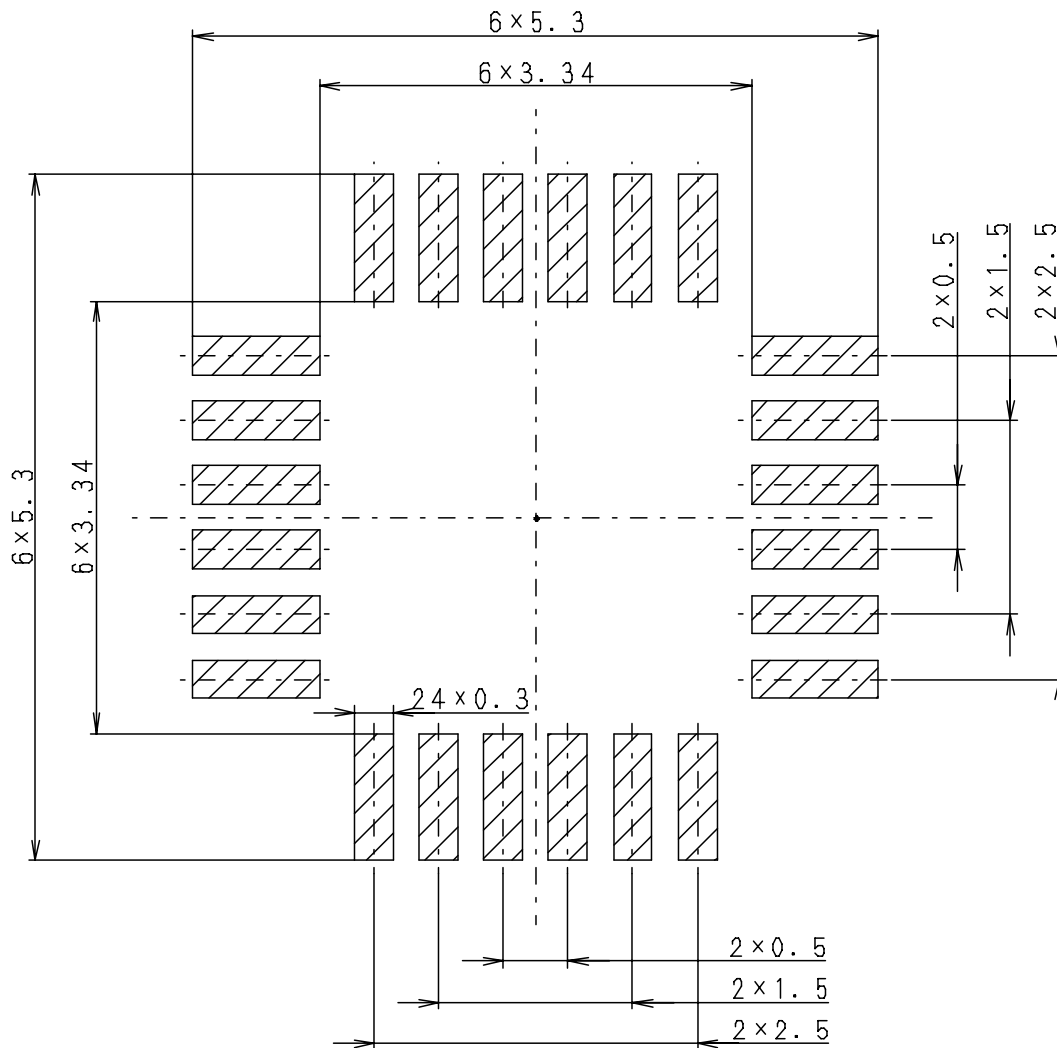

Figure 9-1 Recommended Pattern Layout

10 NOTES FOR PCB MOUNTING

- Do not apply a temperature more than 265 °C to the sensor to avoid damage. Recommended reflow conditions are as follows. Please limit the reflow process only 2 times.
- To avoid multiple reflow steps for the MEMS component, the side where the MEMS is placed shall be soldered last is recommended.
- If the peak temperature is higher or if the heating time is longer than recommended, it may cause degradation of the electrical characteristics and performance over the life of the sensor. Recommended soldering condition is for the guideline for ensuring the basic characteristics of the components, does not guarantee solder joint reliability. Conditions for proper soldering should be determined by individual projects.

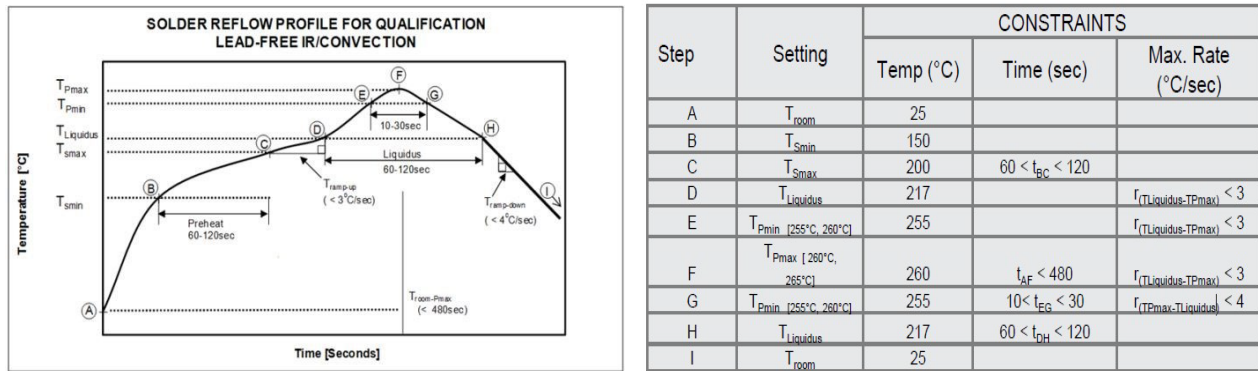

Figure 10-1 Solder Reflow Profile

- For the land of solder mask design, select the normal solder resist (both for terminal and center pad).
- Do not solder the sensor center pad to the PCB. Solder all pins (including all NC pins, but except for the center pad) to the PCB to provide mechanical stability and stress.
- Design the PCB so that the sensor center pad does not contact the PCB surface (create a gap as shown below) in the entire operating temperature range. Sensor temperature characteristics may vary due to contact between the sensor bottom and the PCB.

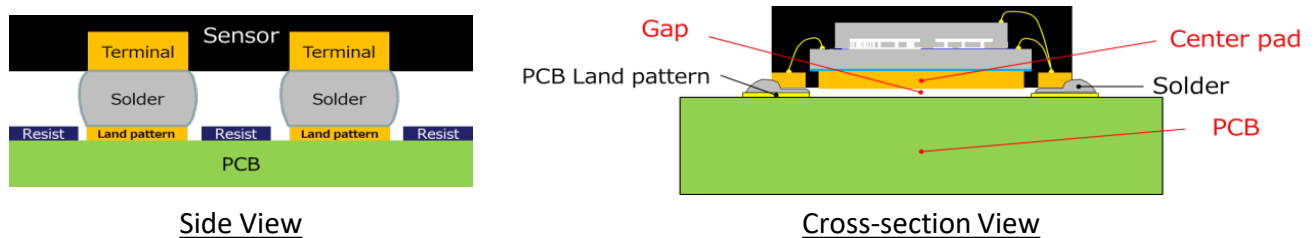

Figure 10-2 Solder Joint

- Solder all NC pins in order to secure sensor on PCB and improve solder reliability.
- For the best performance, design a ground plane in the next layer after the top layer (the top layer shall be free of traces) under the sensor to reduce signal noise from the board on which the sensor is mounted.
- Do not use ultrasonic for cleaning sensor on PCB. MEMS element may be destroyed by its ultrasonic resonance.
- Refrain from washing after mounting the sensor. Please consult in advance if necessary.
- To get the best performance from the sensor do not use underfill, side fill material (adhesive, etc.), and do not apply potting or molding without trials and reliability checks.

- Do not apply more than 10,000G shock to the sensor.
- Do not mount the sensor near the substrate edge or the screw mounting location. The strain applied to the sensor should be less than 500 $\mu\epsilon$ (micro strains).
- The best placement of the sensor on the PCB is depending on the optimization target - tilt accuracy or high frequency vibration suppression – please make sure to consider different places on the PCB. Place the sensor at least 15mm from the PCB edge if you need to suppress vibrations as it is very firmly connected to a big mass (housing, vehicle chassis). If you need to optimize inclination performance it is better to place the sensor in an area with the smallest bending stress - in the middle of the fixation points, far away from the screws, guides, or fixations.
- Do not mount the sensor near parts generating heat to avoid affecting sensor characteristics.
- Do not exceed the guaranteed operating temperature range.
- The sensor should not be mounted near the power control circuit nor high voltage source.
- Do not mount parts such as a switch and a connector on the direct opposite side of the PCB where the sensor is mounted.
- Do not place any signal trace underneath the sensor.
- Do not touch the sensor with bare hands.
- Do not re-mount the sensor. If the sensor is removed from PCB, do not re-use.
- Select PCB board and soldering material carefully not to affect sensor characteristics due to mechanical stress during sensor mounting.
- If the user uses a halogen type (Chlorine type, Bromine type, etc.) high-activity flux, need to evaluate and verify sensor and other components condition, performance, and reliability prior to applying such flux. It may affect the performance and the reliability of this product by the residue of the flux.
- Sensor mounted on PCB should not interfere or have physical contact with any surrounding components and/or any object, even under vibration.
- PCB BOM - components with high mass, high center of gravity like transformers, capacitors, connectors, pushbutton switches, attached piggy packs, memory banks, etc. may be sources of vibrations and even rate signals. Understanding the origin of disturbances can be time consuming - for vibration analysis laser interferometers or cameras with stroboscopic LED lights may help to understand the source of vibrations.
- PCB Layout - solder all pins of the sensor to the lands on the PCB - except for the central pad. Keep the lands identical in shape and area - it is important that there is the same amount of solder at each solder joint between sensor and PCB. This allows symmetric distribution of stress caused by different thermal expansion coefficients (CTE) and perfectly flat mounting on the PCB. When focusing on measuring tilt precisely with the sensor, keep in mind on a package with a length of 4.5mm an inclination angle of 0.5 °(mech.) is equivalent to 39 μm difference in height on both ends. The diameter of hairs is between 20 to 80 μm . The initial error is not so critical as the measurement is mostly calibrated in software, but the strain and bending over temperature or after the mechanical shock of the complete material stack in the product are not well predictable.

11 HANDLING PRECAUTIONS

- Sensor package storage condition should be at $\leq 40^{\circ}\text{C}$, $\leq 90\%\text{R.H.}$. And must be used within 12 months from the packing date. After opening the package, mount the sensor within 168hrs at $\leq 30^{\circ}\text{C}$, $60\%\text{R.H.}$ (MSL 3).
- If overdue on the storage term, do not use the sensor. The device may experience with damage while reflow process due to the rapid evaporation from the absorbed of humidity in the package. It may lead electrical performance degradation to the device and effect to solder reliability.
- Drying conditions is 40°C , $\leq 5\%\text{R.H.}$ 312hrs. Drying is required if the humidity indicator card in sealed the package shows 30% or more as opened, or storage conditions (listed above) is exceeded.
- This sensor is not designed for the extreme environment, so do not storage or use it under the following specific environment. Extreme environmental conditions, such as those listed below, might degrade the sensor performance. Verify total system performance prior to product release.
 - 1) Under any liquid, such as water, oil, chemical solution, and organic solvent.
 - 2) In direct sunlight, outdoor exposure, or dust.
 - 3) In sea breeze or corrosive gas like Cl_2 , H_2S , NH_3 , SO_2 , NO_x .
 - 4) In static electricity, electromagnetic wave, or radiation
 - 5) Where the product is close to a heat-generating component, or where an inflammable such as polyvinyl chloride (PVC) insulated wire.
 - 6) In sealed or coated with resin, etc. product.
 - 7) Flux cleaning by solvent, water, or aqueous solution. (Particularly water-soluble flux.)
 - 8) Condensation.
 - 9) Use the product in a contaminated condition and environment. (Do not handle the sensor mounted on PCB directly with hands with skin moisturizer cream.)
- Do not disassemble and modify this sensor.
- Do not throw the sensor into the fire, apply high temperature or close to a high heat source.
- If this product is dropped on to floor or another hard surface, it could be damaged mechanically or electrically. Do not use the dropped sensor.
- PCB substrate resonance by external vibration (frequency band described in 4.4) might damage MEMS. After installing the sensor to the system unit, evaluate and ensure with vibration test.
- There is a possibility that the accelerometer MEMS element could contact stoppers by applying shocks described below. About the gyro MEMS element, there is no possibility to contact the stopper below 20kHz and 3,000G.
- Contacting stopper doesn't mean that it will cause sensor characteristic degradation immediately. Therefore, this table is just a reference value for establishing assembling shock criteria at customer production line etc. If some assembling process excess the minimum contact shock level, please evaluate adequate sample quantities with pre/post assembly process to set safe criteria for these shock limit which shall not causing sensor characteristic degradation.

Table 11-1 Minimum shock level which lead MEMS contact to its stopper from XYZ direction

Frequency (kHz)	Acceleration (g-pk)
0 - 1	110
1 - 10	86
10 - 13	260
13 - 20	120
20 - 43	392

- To dispose of the sensor, please obey local law and method.
- In handling this sensor, please take ESD measures for suppressing electrical static within the level defined by ESD HBM and ESD CDM shown in "Table 12-1 Reliability Test Items" to your process and also for machine.

12 RELIABILITY TEST ITEMS

Panasonic conducted reliability tests based on AEC-Q100 Grade 1. The main test items are described in Table 12-1. Please contact Panasonic for other test items other than those listed in Table 12-1.

Table 12-1 Reliability Test Items

No.	Item	Condition
1	PC	PC before THB, HAST, AC, UHST, TC. Drying: 125°C for 24 hours ⇒Humidification: 192hours at 30°C, 60% RH (MSL3, J-STD-020) ⇒Reflow 3times (according to J-STD-020)
2	THB	PC before THB 85°C, 85%RH, 3.6V for 1000 hours
3	AC	PC before AC 121°C, 100%RH, 205kPa for 96 hours
4	TC	PC before TC -55°C ⇔+150°C for 1000 cycles
5	HTSL	+150°C for 1000 hours
6	HTOL	+125°C, 3.6V for 1000 hours
7	ESD_HBM	100pF, 1.5kΩ, ±2kV for each terminal
8	ESD_CDM	±500V for each terminal
9	LU	±200mA
10	EMC	Based on SAE J1752/3
11	MS	1500G, 0.5ms, 5 times for each axis
12	VFV	50G, 20Hz to 2kHz to 20Hz for 4 times in each axis
13	CA	30,000G constant acceleration
14	DROP	From a height of 1.2m onto a concrete surface for 1 time on each of 6 axes

13 PACKAGING SPECIFICATION

The 6in1 sensor will be shipped in cushioned tape and reel packing with additional inside and outside packing. Detailed information is described below. Tape & reel size comply with EIA-481, except for the sensor recognition mark orientation in the package. The details for sensor recognition mark orientation in the package are described in Figure 13-2.

- 1) Packaging size: 4000 pieces/reel
- 2) Packaging weight: approx. 1 kg
- 3) Part weight: approx. 0.08g
- 4) Reel size:

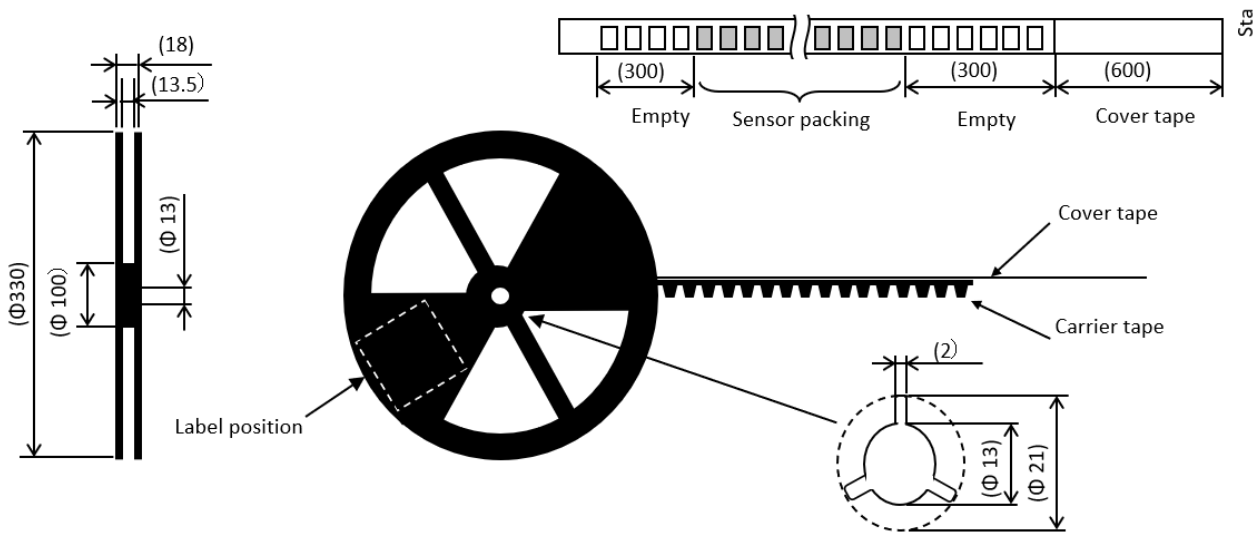

Figure 13-1 Reel Size

- 5) Carrier tape size

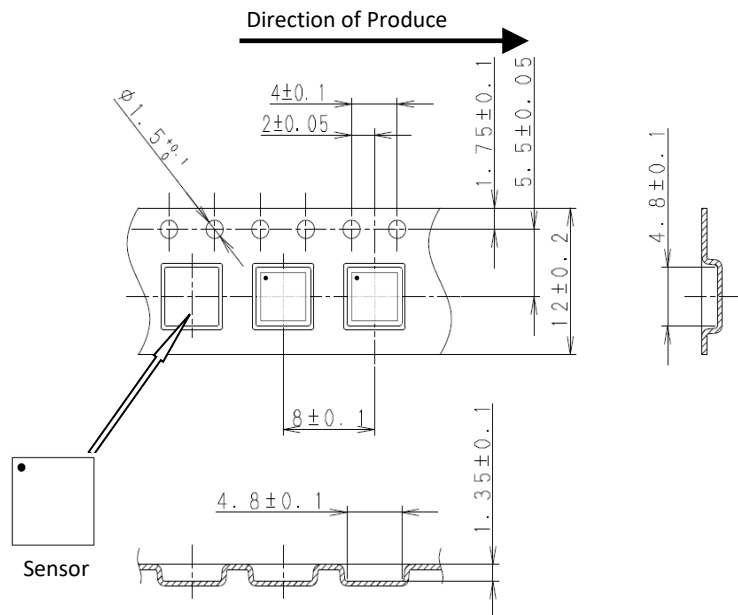

Figure 13-2 Tape Size and Detail

6) Cover tape exfoliation intensity: 0.1N – 1.3 N

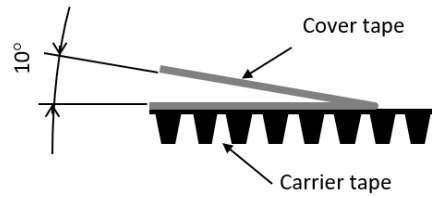

Figure 13-3 Carrier Tape detail

7) Inside packing form

L x W x H = 345 x 360 x 50 (mm)

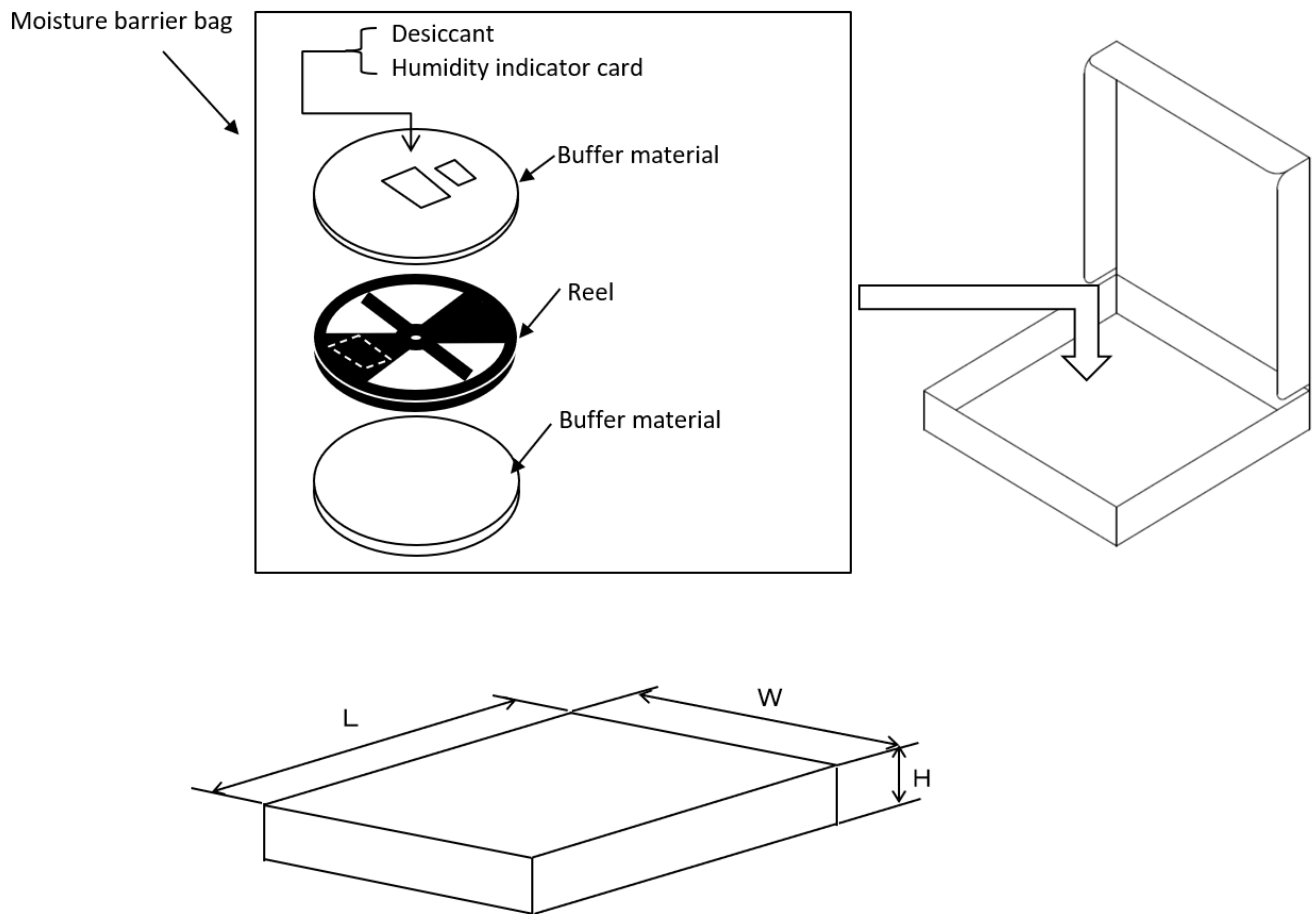

Figure 13-4 Packaging Detail

The moisture barrier bag is compliant with ANSI/ESD S20.20 and ANSI/ESD S541 packing standard.

8) Outside Packaging form (overseas only)

$L \times W \times H = 370 \times 370 \times 250$

1 to 4 real/box

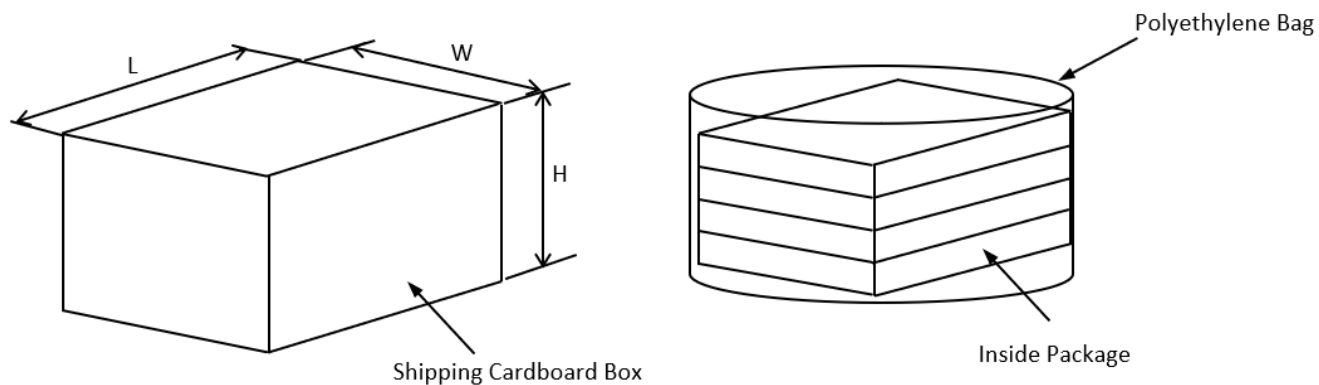

Figure 13-5 Outside Packaging Form

14 IMPORTANT NOTICE

- Inertial measurement sensors are measuring motion like rotation, inclination, shocks, vibrations. When embedding the sensor into the application, the physical fixation of the sensor already creates inclination, rotation, vibration, stress, or bending, which are only under the control of the users. Often there are limitations that do not allow us to choose the ideal solution. Therefore, it is important to understand the potential implications of the intended realization of the application. In order to keep the sensor's intrinsic performance, the user needs to follow the description in this datasheet. Make sure to evaluate and verify sensor performance after you have installed the sensor in your application.
- Care must be taken for the supply voltage circuit design to avoid generating high voltage which is larger than the rated voltage in transient and instantaneous high voltage etc.
- Deviating from this specification may cause the sensor to malfunction and could not guarantee the sensor performance.
- We will continue to improve the quality and the reliability of the sensor, but the performance and durability result may differ depending on the use of conditions and environment.
- Be sure to confirm the sensor performance with the actual product under the actual use conditions.
- Installing the sensor to following systems or products may cause the loss of human life or other significant damage. Therefore, evaluate and incorporate failsafe design to ensure its safety (including but not limited to automotive, train, vessel, transportation system, medical equipment, aerospace, electric heating appliances, combustion/gas equipment, machining/rotating equipment, and disaster/crime prevention equipment).
 - The system should be equipped with a protection circuit and protection device.
 - The system should be equipped with redundant or other fail-safe circuits to prevent an unsafe status in the event of a single fault.
- If there is any concern related to the sensor and securing the safety of the application, please notify us promptly. Your own engineering level evaluation of the use of the sensor must be conducted.
- The technical information in this specification provides examples of our Sensors' characterizations etc. We do not guarantee the non-infringement of third party's intellectual property rights and we do not grant any license, right, or interest in our intellectual property. We do not take any responsibility if third party related right issues occur due to this sensor usage by any possibility.
- This Product Specification is the only binding description of the specifications of this product, and shall always supersede and take precedence over any other written or oral information (including by email) communicated at any time between your company and our company, whether before or after the date of this Product Specification. Any additions, deletions, or modifications to the specifications of this product shall be invalid, null and void unless a revised Product Specification is executed by both parties.

15 REVISION HISTORY

Rev.	Date	Content of Change	Reasons	Name	Check
1.01	6/1/2021	-	New release	Y. Nakayoshi	T. Arai