

## Magneto Resistive Elements (MR Elements)

Type: EZMP



Panasonic MR Sensor is a magnetic sensor in which magneto resistive element is used with a magnet rotator / scale, pre-magnetized at an accuracy pitch of 0.1 mm to 1.0 mm. With this combination, a highly accurate control can be realized and can be used for various application.

### Features

- Flat sensing surface  
(Precise and easy to assemble)
- Short turn around-time by standardized pitch and shape
- High speed and accuracy control possible
- RoHS compliant

### Recommended Applications

- Capstan motors (Rotation speed)
- Camera lens unit (Position)
- Printers (Printing timing)
- Counter (Number of rotations)
- Disc drive actuator (Position)

### Explanation of Part Numbers

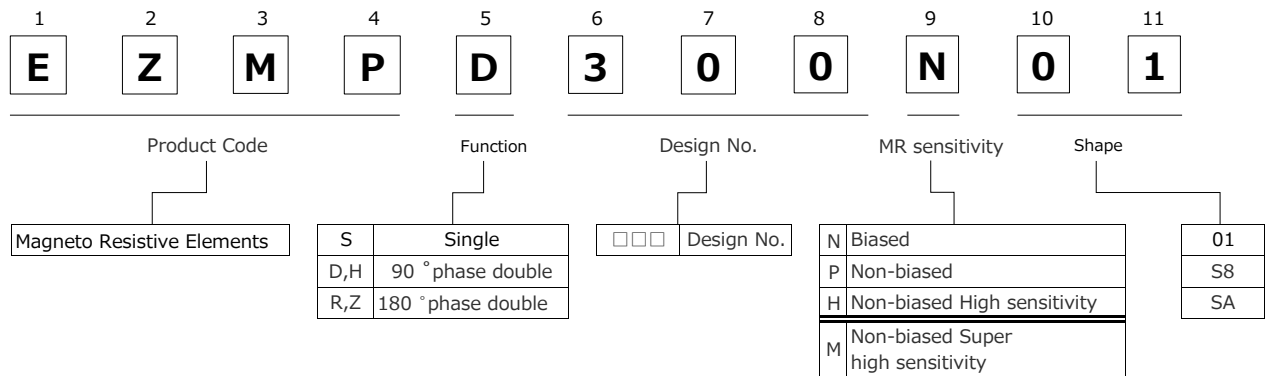

### Construction

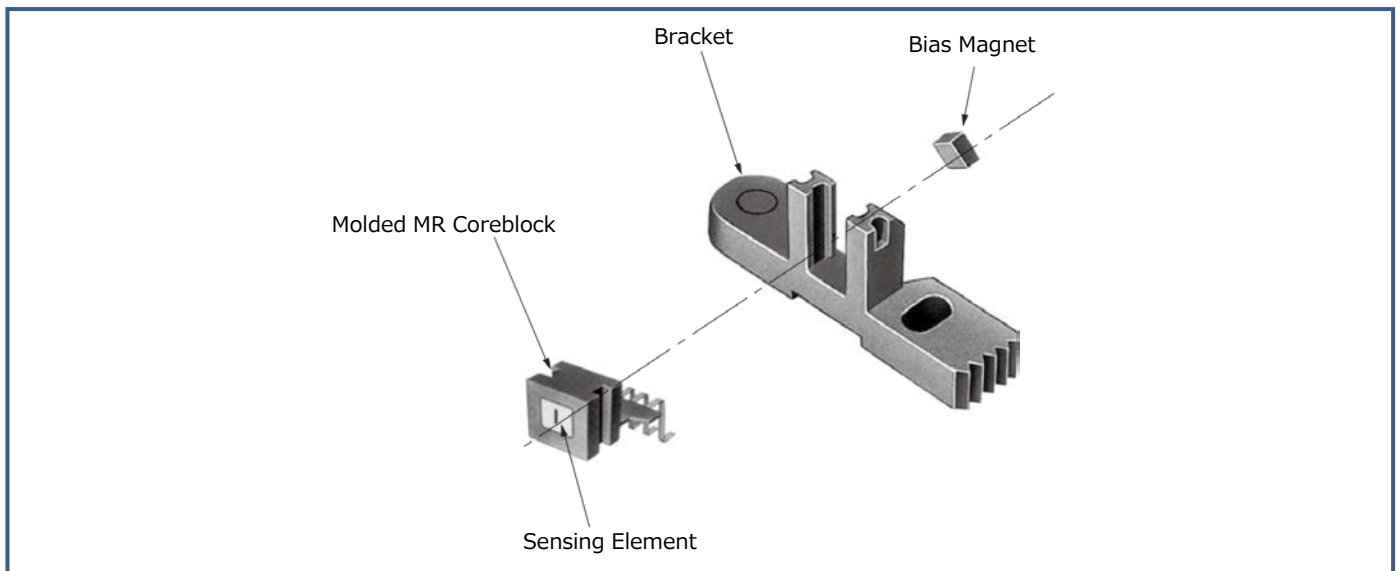

**Dimensions in mm (not to scale)**

**01 Bracket Assembly**

- Available for both biased type and non-biased type

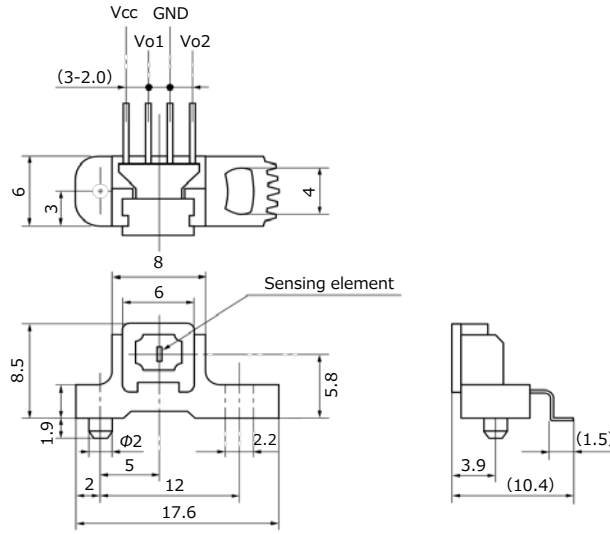

**S8 Bracket Assembly  
"S Petit Mold MR"**

- Available for only non-biased type

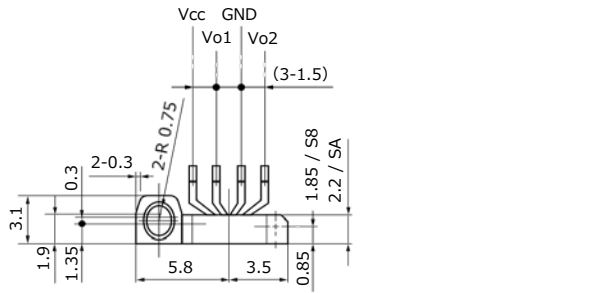

**SA Bracket Assembly  
"S Petit Mold MR"**

- Available for only biased type

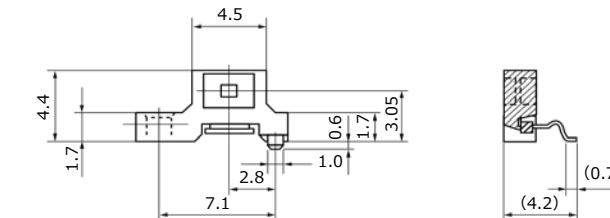

**Performance Specifications, Summary**

Item	Characteristics
Resistance Value	1 kΩ (standard) ±30 %
Sensing Range	1600 A/m to 16000 A/m
Pitch Density	0.1 mm min.
Category Temperature Range	-30 °C to +70 °C
Applied Voltage	5 V (standard)
Resistance Change by Magnetic Force	N: 3 % min. (at ±16000 A/m) P: 2 % min. (at ±16000 A/m) M: 6 % min. (at ±16000 A/m)
Resistance Pair-Matching	<p>Circuit Diagram</p> $\frac{R_B}{R_A + R_B} = (50 \pm 0.6) \%$

**Packaging Methods**

Part No.	Standard Quantity	Style	Mass (Weight) (g/ pc)
EZMP□□□□□01	3,600 pcs	Tray	0.58
EZMP□□□□□SA	15,000 pcs	Tray	0.12
EZMP□□□□□S8	15,000 pcs	Tray	0.09

**Application Examples**

**1. Detection of rotations**

(1) Detection of position  
EZM detects the magnetized spot on a rotator.

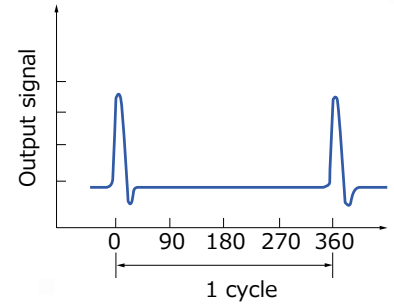
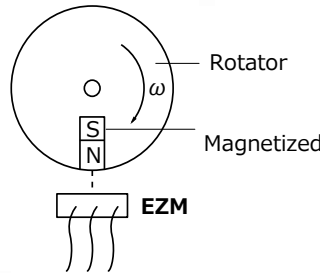

(2) Detection of rotation angle  
The circumference of a rotator has been magnetized as shown in the figure on the right. EZM detects a rotation angle by analyzing wave forms.

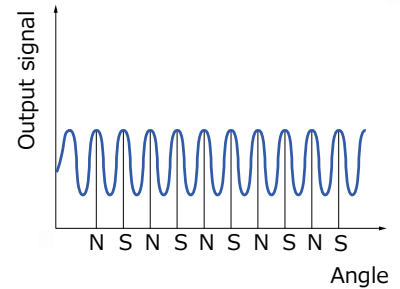
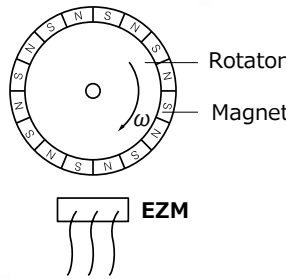

(3) Detection of number of rotations

**Examples of Applications**

- To sense movement without contact
- To sense weak signals that a Hall Sensor can't do
- Can sense more precisely accurately than a Hall Sensor
- To get more stabilized output voltage from ring head
- To substitute for optical sensor in dusty environment
- To sense at a higher speed than an optical sensor
- To sense at a higher speed or a higher accuracy than a stepping motor

**⚠ Safety Precautions**

The following are precautions for individual products. Please also refer to the common precautions for MR Sensors in this catalog.

1. Solder Magneto Resistive Elements (hereafter called the MR Elements) at their terminal tips at 260 °C or lower for no more than 10 seconds.
2. Do not apply excessive shock, such as a drop impact, to the MR Elements' bodies or terminals.
3. Do not use any corrosive adhesives, such as those made of acid, alkali, or base, or any adhesives that apply stress to the MR Elements.
4. Do not wash the MR Elements with organic solvents.

MR Elements Inquiry Work Sheet	
Please fill out the following items and send with your request.	
Your name	
Please give your adress and phone number to our sales staff.	
Sensing Item	1) Rotation speed 2) Rotation angle/direction 3) Linear speed 4) Linear position 5) Approach 6) Flow 7) Direction 8) Current
Application Set.	1)VCR 2)Camera 3)Motor 4)Water-flow-meter 5)Other ( )
Projected Quantity	Projected Qty. _____ Monthly Rate _____ /M
Manufacturing Schedule	E.S. _____ , P.P. _____ , M.P. _____ Engineering sample Pilot production Mass production
Detecting (FINE) Pitch	_____ μm or _____ mm
Sample Required	EZM _____ x _____ pcs
Additional Comments:	
Questions:	
If you couldn't use MR elements, What's alternative?	1)Hall Element/IC 2)Magnetic head 3)Coil 4)Coil pattern 5)Optical sensor 6)Eddy current 7)Other ( )
We appreciate your input. Thank you.	

**Guidelines and precautions regarding the technical information and use of our products described in this online catalog.**

- If you want to use our products described in this online catalog for applications requiring special qualities or reliability, or for applications where the failure or malfunction of the products may directly jeopardize human life or potentially cause personal injury (e.g. aircraft and aerospace equipment, traffic and transportation equipment, combustion equipment, medical equipment, accident prevention, anti-crime equipment, and/or safety equipment), it is necessary to verify whether the specifications of our products fit to such applications. Please ensure that you will ask and check with our inquiry desk as to whether the specifications of our products fit to such applications use before you use our products.
- The quality and performance of our products as described in this online catalog only apply to our products when used in isolation. Therefore, please ensure you evaluate and verify our products under the specific circumstances in which our products are assembled in your own products and in which our products will actually be used.
- If you use our products in equipment that requires a high degree of reliability, regardless of the application, it is recommended that you set up protection circuits and redundancy circuits in order to ensure safety of your equipment.
- The products and product specifications described in this online catalog are subject to change for improvement without prior notice. Therefore, please be sure to request and confirm the latest product specifications which explain the specifications of our products in detail, before you finalize the design of your applications, purchase, or use our products.
- The technical information in this online catalog provides examples of our products' typical operations and application circuits. We do not guarantee the non-infringement of third party's intellectual property rights and we do not grant any license, right, or interest in our intellectual property.
- If any of our products, product specifications and/or technical information in this online catalog is to be exported or provided to non-residents, the laws and regulations of the exporting country, especially with regard to security and export control, shall be observed.

**<Regarding the Certificate of Compliance with the EU RoHS Directive/REACH Regulations>**

- The switchover date for compliance with the RoHS Directive/REACH Regulations varies depending on the part number or series of our products.
- When you use the inventory of our products for which it is unclear whether those products are compliant with the RoHS Directive/REACH Regulation, please select "Sales Inquiry" in the website inquiry form and contact us.

**We do not take any responsibility for the use of our products outside the scope of the specifications, descriptions, guidelines and precautions described in this online catalog.**

## Safety Precautions (Common precautions for MR Sensors)

- When using our products, no matter what sort of equipment they might be used for, be sure to make a written agreement on the specifications with us in advance. The design and specifications in this catalog are subject to change without prior notice.
- Do not use the products beyond the specifications described in this catalog.
- This catalog explains the quality and performance of the products as individual components. Before use, check and evaluate their operations when installed in your products under the actual conditions for use.
- Install the following systems for a failsafe design to ensure safety if these products are to be used in equipment where a defect in these products may cause the loss of human life or other significant damage, such as damage to vehicles (automobile, train, vessel), traffic lights, medical equipment, aerospace equipment, electric heating appliances, combustion/gas equipment, rotating equipment, and disaster/crime prevention equipment.
- \* Systems equipped with a protection circuit and a protection device.
- \* Systems equipped with a redundant circuit or other system to prevent an unsafe status in the event of a single fault.
- \* Systems equipped with an arresting the spread of fire or preventing glitch.

### (1) Precautions for use

- These products are designed and manufactured for general and standard use in general electronic equipment. (e.g. AV equipment, home electric appliances, office equipment, information and communication equipment)  
For applications in which special quality and reliability are required, or if the failure or malfunction of the products may directly jeopardize life or cause threat of personal injury (such as for aircraft and aerospace equipment, traffic and transport equipment, combustion equipment, medical equipment, accident prevention and anti-theft devices, and safety equipment), please be sure to consult with our sales representative in advance and to exchange product specifications which conform to such applications.
- These products are not intended for use in the following special conditions. Before using the products, carefully check the effects on their quality and performance, and determine whether or not they can be used.
  1. In liquid, such as water, oil, chemicals, or organic solvent.
  2. In direct sunlight, outdoors, or in dust.
  3. In salty air or air with a high concentration of corrosive gas, such as  $\text{Cl}_2$ ,  $\text{H}_2\text{S}$ ,  $\text{NH}_3$ ,  $\text{SO}_2$ , or  $\text{NO}_x$ .
  4. Electric Static Discharge (ESD) Environment.  
These components are sensitive to static electricity and can be damaged under static shock (ESD). Please take measures to avoid any of these environments.  
Smaller components are more sensitive to ESD environment.
  5. Electromagnetic and Radioactive Environment.  
Avoid any environment where strong electromagnetic waves and radiation exist.
  6. In an environment where these products cause dew condensation.
  7. Sealing or coating of these products or a printed circuit board on which these products are mounted, with resin or other materials.
- These products generate Joule heat when energized. Carefully position these products so that their heat will not affect the other components.
- Carefully position these products so that their temperatures will not exceed the category temperature range due to the effects of neighboring heat-generating components. Do not mount or place heat-generating components or inflammables, such as vinyl-coated wires, near these products.
- Note that non-cleaning solder, halogen-based highly active flux, or water-soluble flux may deteriorate the performance or reliability of the products.
- Carefully select a flux cleaning agent for use after soldering. An unsuitable agent may deteriorate the performance or reliability. In particular, when using water or a water-soluble cleaning agent, be careful not to leave water residues. Otherwise, the insulation performance may be deteriorated.
- Do not apply flux to these products after soldering. The activity of flux may be a cause of failures in these products.
- Refer to the recommended soldering conditions and set the soldering condition. High peak temperature or long heating time may impair the performance or the reliability of these products.
- Recommended soldering condition is for the guideline for ensuring the basic characteristics of the products, not for the stable soldering conditions. Conditions for proper soldering should be set up according to individual conditions.

- Do not reuse any products after removal from mounting boards.
- Do not drop these products. If these products are dropped, do not use them. Such products may have received mechanical or electrical damage.
- If any doubt or concern to the safety on these products arise, make sure to inform us immediately and conduct technical examinations at your side.

## **(2) Precautions for storage**

The performance of these products, including the solderability, is guaranteed for a year from the date of arrival at your company, provided that they remain packed as they were when delivered and stored at a temperature of 5 °C to 35 °C and a relative humidity of 45 % to 85 %.

The performance of Chip MR is guaranteed for 3 months after our delivery, provided that they are stored at a temperature of 5 °C to 35 °C and a relative humidity of 45 % to 85 %.

Even within the above guarantee periods, do not store these products in the following conditions.

Otherwise, their electrical performance and/or solderability may be deteriorated, and the packaging materials (e.g. taping materials) may be deformed or deteriorated, resulting in mounting failures.

1. In salty air or in air with a high concentration of corrosive gas, such as Cl<sub>2</sub>, H<sub>2</sub>S, NH<sub>3</sub>, SO<sub>2</sub>, or NO<sub>x</sub>.
2. In direct sunlight.

<Package markings>

Package markings include the product number, quantity, and country of origin.

In principle, the country of origin should be indicated in English.