

Chip Inductors
High Frequency Use High-Q (Non Magnetic Core)

Type: **ELJQF**
ELJQE

Discontinued



■ Features

- High frequency capability due to its non magnetic core.
- Capable of being Re-flow or flow soldered.
- Unique Ceramic Core / Laser-cut Technology.
- Non polarity product.
- High self resonance frequency.
- Good for mounting.
- RoHS compliant

■ Recommended Applications

- RF circuitry for cellular phones and wireless communication equipment.

■ Explanation of Part Numbers

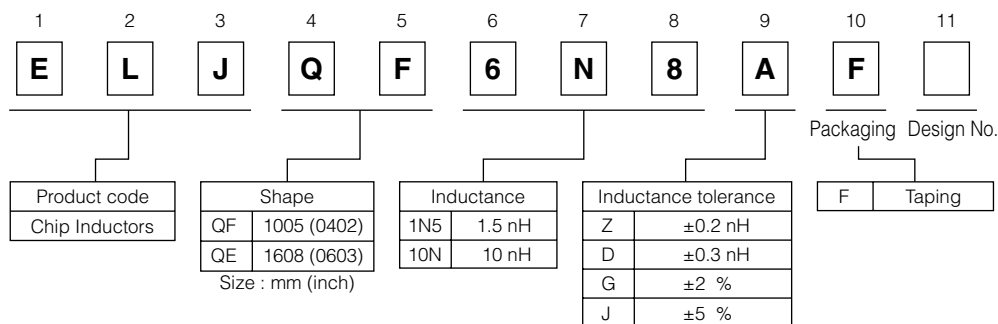

■ Storage Conditions

- Package : Normal temperature (−5 to 35 °C), normal humidity (85 %RH max.), shall not be exposed to direct sunlight and harmful gases and care should be taken so as not to cause dew.
- Operating Temperature : −40 to +85 °C

■ Storage Period

- Solderability may be reduced due to the conditions of high temperature and high humidity which causes the oxidation of tin-plated terminals. Even if storage conditions are within specified limits, solderability may be reduced with the passage of time. Therefore, please control the storage conditions and try to use the product within 6 months of receipt.

■ Packaging Methods, Soldering Conditions and Safety Precautions

Please see Data Files.

■ QF Type 1005 (0402)

● Dimensions in mm (not to scale)

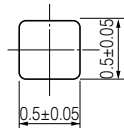
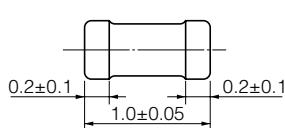

● Recommended Land Pattern in mm (not to scale)

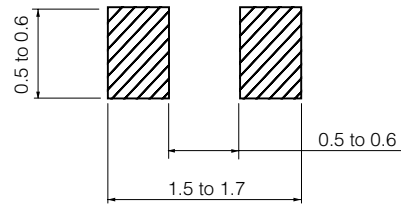

■ Standard Packing Quantity

● 10000 pcs./Reel

■ Standard Parts (E12 series)

Part No.	Inductance			Q		SRF *1 (MHz) min.	R _{DC} *2 (Ω) max.	DC Current (mA) max.
	(nH)	Tolerance (%)	Test Freq. (MHz)	100 MHz min.	800 MHz typ.			
ELJQF1N0□F	1.0	D : ±0.3 nH Z : ±0.2 nH	100	10	41	6000	0.05	400
ELJQF1N2□F	1.2				41	6000	0.06	400
ELJQF1N5□F	1.5				40	6000	0.07	400
ELJQF1N8□F	1.8				40	6000	0.08	400
ELJQF2N2□F	2.2				40	6000	0.09	400
ELJQF2N7□F	2.7				40	5500	0.10	400
ELJQF3N3□F	3.3				39	5500	0.12	400
ELJQF3N9□F	3.9				39	5200	0.15	360
ELJQF4N7□F	4.7				39	4800	0.17	360
ELJQF5N6□F	5.6				39	4600	0.19	340
ELJQF6N8□F	6.8	J : ±5 % G : ±2 %	100	10	39	4000	0.30	320
ELJQF8N2□F	8.2				39	3500	0.35	320
ELJQF10N□F	10				39	2800	0.41	320
ELJQF12N□F	12				38	2800	0.45	320
ELJQF15N□F	15				36	2500	0.60	240
ELJQF18N□F	18				36	2200	0.70	240
ELJQF22N□F	22				36	2000	0.80	200
ELJQF27N□F	27				36	1800	1.20	200
ELJQF33N□F	33				35	1800	1.40	170
ELJQF39N□F	39				35	1800	1.70	150

□ : Symbol of Tolerance *1 : Self Resonant Frequency *2 : DC Resistance

■ Standard Parts (E24 series)

Part No.	Inductance			Q		SRF *1 (MHz) min.	R _{DC} *2 (Ω) max.	DC Current (mA) max.
	(nH)	Tolerance (%)	Test Freq. (MHz)	100 MHz min.	800 MHz typ.			
ELJQF1N1□F	1.1	D : ±0.3 nH Z : ±0.2 nH	100	10	41	6000	0.06	400
ELJQF1N3□F	1.3				40	6000	0.07	400
ELJQF1N6□F	1.6				40	6000	0.08	400
ELJQF2N0□F	2.0				40	6000	0.09	400
ELJQF2N4□F	2.4				40	5500	0.10	400
ELJQF3N0□F	3.0				39	5500	0.12	400
ELJQF3N6□F	3.6				39	5300	0.14	380
ELJQF4N3□F	4.3				39	5000	0.16	360
ELJQF5N1□F	5.1				39	4700	0.18	350
ELJQF6N2□F	6.2				39	4300	0.25	330
ELJQF7N5□F	7.5	J : ±5 % G : ±2 %	100	10	39	3700	0.33	320
ELJQF9N1□F	9.1				39	3100	0.38	320
ELJQF11N□F	11				38	2800	0.43	320
ELJQF13N□F	13				36	2600	0.53	280
ELJQF16N□F	16				36	2300	0.65	240
ELJQF20N□F	20				36	2100	0.75	220
ELJQF24N□F	24				36	1900	1.00	200
ELJQF30N□F	30				35	1800	1.30	190
ELJQF36N□F	36				35	1800	1.60	160

□ : Symbol of Tolerance *1 : Self Resonant Frequency *2 : DC Resistance

■ ELJQF Type

■ Typical Characteristics

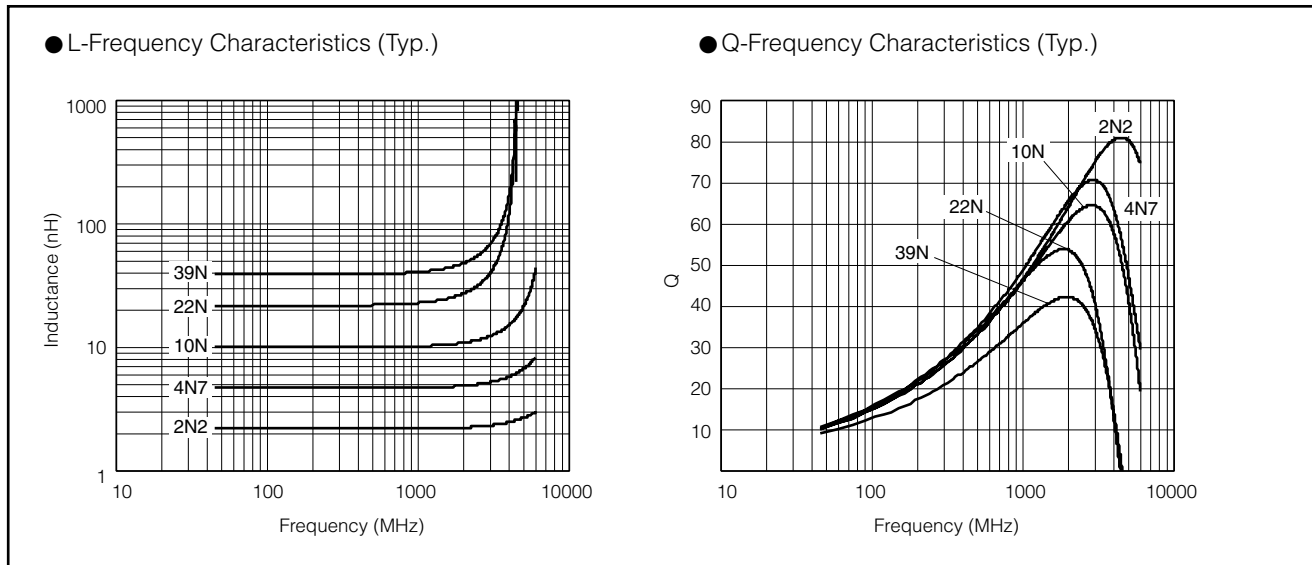

■ Reference Data

Part No.	Inductance (nH)(Typ.)					Q(Typ.)				
	800MHz	900MHz	1.8GHz	2.0GHz	2.4GHz	800MHz	900MHz	1.8GHz	2.0GHz	2.4GHz
ELJQF1N0□F	1.00	1.00	1.01	1.01	1.02	42.8	46.1	64.1	67.7	73.6
ELJQF1N2□F	1.20	1.21	1.22	1.22	1.23	44.4	47.1	65.8	69.0	75.1
ELJQF1N5□F	1.51	1.51	1.53	1.53	1.55	43.7	46.4	64.5	67.6	73.3
ELJQF1N8□F	1.78	1.78	1.81	1.82	1.84	40.0	42.4	58.8	61.5	66.6
ELJQF2N2□F	2.19	2.19	2.24	2.25	2.28	41.9	44.5	61.4	64.2	69.3
ELJQF2N7□F	2.73	2.73	2.79	2.81	2.85	46.3	49.1	67.7	70.7	76.2
ELJQF3N3□F	3.32	3.33	3.40	3.43	3.48	47.2	50.0	68.8	71.8	77.1
ELJQF3N9□F	3.98	3.99	4.11	4.15	4.24	43.0	45.6	62.0	64.4	68.4
ELJQF4N7□F	4.70	4.71	4.86	4.91	5.02	44.1	46.8	63.2	65.6	69.1
ELJQF5N6□F	5.59	5.60	5.80	5.87	6.02	44.2	46.9	63.6	66.1	70.3
ELJQF6N8□F	6.82	6.84	7.13	7.22	7.46	42.6	45.1	60.4	62.5	65.4
ELJQF8N2□F	8.33	8.35	8.76	8.89	9.22	41.3	43.7	58.2	60.0	62.3
ELJQF10N□F	10.14	10.18	10.76	10.94	11.42	41.8	44.2	58.8	60.8	63.5
ELJQF12N□F	12.0	12.1	12.9	13.2	13.9	44.1	46.7	59.9	61.0	60.9
ELJQF15N□F	15.2	15.3	16.7	17.2	18.4	42.3	44.6	56.2	56.8	55.7
ELJQF18N□F	18.3	18.4	20.2	20.8	22.5	43.4	45.7	55.8	55.5	52.1
ELJQF22N□F	22.5	22.8	26.2	27.4	30.9	42.4	44.6	53.8	53.7	50.8
ELJQF27N□F	27.8	28.1	33.3	35.3	41.2	39.6	41.6	48.8	48.1	44.1
ELJQF33N□F	33.7	34.0	38.4	40.0	44.3	35.6	37.4	45.4	45.3	42.9
ELJQF39N□F	40.1	40.5	46.2	48.2	53.9	32.8	34.5	42.2	42.3	40.9

□ : Symbol of Tolerance

■ QE Type 1608 (0603)

● Dimensions in mm (not to scale)

● Recommended Land Pattern in mm (not to scale)

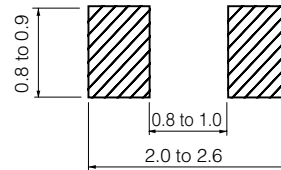
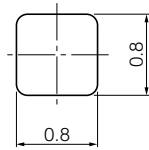
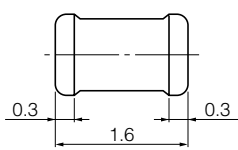

■ Standard Packing Quantity

● 3000 pcs./Reel

■ Standard Parts (E12 series)

Part No.	Inductance			Q		SRF *1 (MHz) min.	R _{DC} *2 (Ω) max.	DC Current (mA) max.				
	(nH)	Tolerance (%)	Test Freq. (MHz)	100 MHz min.	800 MHz typ.							
ELJQE2N2□FA	2.2	D : ±0.3 nH Z : ±0.2 nH	100	15	88.6	6000	0.04	970				
ELJQE2N7□FA	2.7				65.4	6000	0.05	880				
ELJQE3N3□FA	3.3				61.3	6000	0.06	800				
ELJQE3N9□FA	3.9				68.4	6000	0.07	750				
ELJQE4N7□FA	4.7				65.2	6000	0.09	660				
ELJQE5N6□FA	5.6				57.4	6000	0.11	600				
ELJQE6N8□FA	6.8	J : ±5 % G : ±2 %			100	15	65.0	6000	0.14	540		
ELJQE8N2□FA	8.2						65.5	5700	0.17	490		
ELJQE10N□FA	10						63.8	5300	0.21	450		
ELJQE12N□FA	12						61.9	4900	0.26	400		
ELJQE15N□FA	15						59.0	4400	0.34	350		
ELJQE18N□FA	18						58.6	4000	0.41	320		
ELJQE22N□FA	22	J : ±5 % G : ±2 %					100	15	59.1	3700	0.52	290
ELJQE27N□FA	27								55.0	3400	0.66	260
ELJQE33N□FA	33								54.2	3000	0.82	230
ELJQE39N□FA	39								52.9	2800	1.00	210
ELJQE47N□FA	47								54.4	2500	1.23	190
ELJQE56N□FA	56								51.5	2500	1.51	180

□ : Symbol of Tolerance *1 : Self Resonant Frequency *2 : DC Resistance

■ ELJQE Type

■ Typical Characteristics

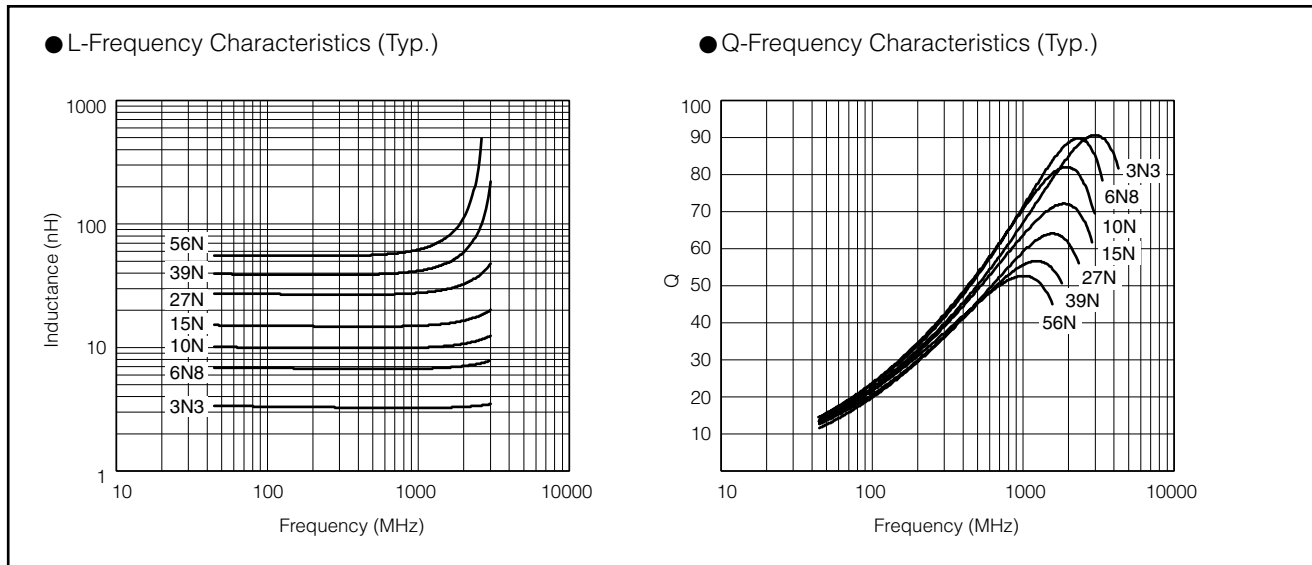

■ Reference Data

Part No.	Inductance (nH)(Typ.)					Q(Typ.)				
	800MHz	900MHz	1.8GHz	2.0GHz	2.4GHz	800MHz	900MHz	1.8GHz	2.0GHz	2.4GHz
ELJQE2N2□FA	2.18	2.18	2.23	2.25	2.30	88.6	92.5	117.0	119.5	122.5
ELJQE2N7□FA	2.62	2.62	2.69	2.71	2.78	65.4	68.4	87.2	89.3	92.4
ELJQE3N3□FA	3.24	3.24	3.29	3.30	3.36	61.3	64.2	82.6	84.9	88.7
ELJQE3N9□FA	3.83	3.83	3.91	3.93	4.01	68.4	71.9	94.8	97.6	102.1
ELJQE4N7□FA	4.61	4.61	4.74	4.78	4.91	65.2	68.4	88.3	90.4	93.0
ELJQE5N6□FA	5.48	5.48	5.62	5.67	5.82	57.4	60.1	77.2	79.2	82.0
ELJQE6N8□FA	6.70	6.71	6.96	7.05	7.30	65.0	68.2	87.0	88.6	89.7
ELJQE8N2□FA	8.12	8.14	8.57	8.71	9.12	65.5	68.4	84.0	84.7	83.5
ELJQE10N□FA	9.89	9.92	10.5	10.7	11.3	63.8	66.7	81.5	82.1	80.5
ELJQE12N□FA	12.0	12.0	12.9	13.1	14.0	61.9	64.6	77.8	78.0	75.4
ELJQE15N□FA	14.9	14.9	16.1	16.4	17.6	59.0	61.4	72.1	72.0	69.0
ELJQE18N□FA	18.0	18.1	20.1	20.8	22.9	58.6	61.0	70.1	69.2	64.0
ELJQE22N□FA	22.0	22.1	24.9	25.9	29.0	59.1	61.3	67.8	66.1	59.0
ELJQE27N□FA	27.1	27.3	31.2	32.5	36.7	55.0	57.2	63.3	61.6	54.3
ELJQE33N□FA	33.9	34.4	43.7	47.4	61.4	54.2	55.9	54.7	51.0	39.1
ELJQE39N□FA	40.3	40.9	53.6	58.9	79.9	52.9	54.4	50.6	46.3	33.2
ELJQE47N□FA	49.6	50.5	72.7	83.1	134.8	54.4	55.4	44.2	38.1	21.6
ELJQE56N□FA	58.8	60.1	93.6	111.2	223.8	51.5	52.3	37.7	30.9	13.6

□ : Symbol of Tolerance

■ Packaging Methods (Taping)

● Punched Carrier Tape Dimensions in mm (not to scale)



● Type □F

	A	B	W	E	F	P ₁
RF, QF, PF	0.71	1.21	8.0	1.75	3.5	2.0
	P ₂	P ₀	φD ₀	t ₁	t ₂	
RF, QF, PF	2.0	4.0	φ1.5	0.7 max.	1.0 max.	

● Embossed Carrier Tape Dimensions in mm (not to scale)

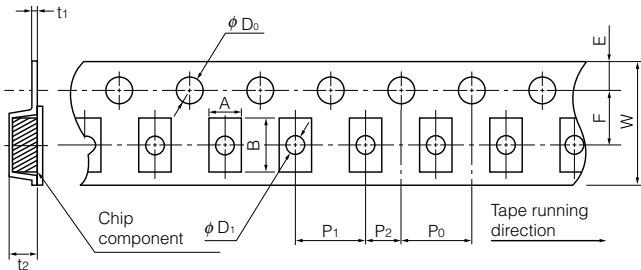

● Type □E

	A	B	W	E	F	P ₁
RE, QE, PE	1.0	1.8	8.0	1.75	3.5	4.0
	P ₂	P ₀	φD ₀	φD ₁	t ₁	t ₂
RE, QE, PE	2.0	4.0	φ1.5	φ0.6	(0.27)	1.2

● Taping Reel Dimensions in mm (not to scale)

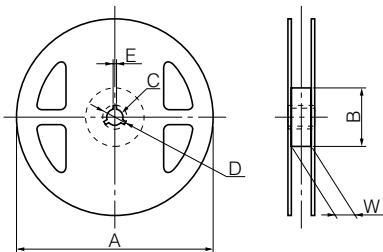

Types	Parts					
	A	B	C	D	E	W
RF, QF, PF	180	60	13	21	2	9
RE, QE, PE						

■ Standard Packing Quantity/Reel

Types	Quantity	Quantity
RF, QF, PF		10000 pcs.
RE, QE, PE		3000 pcs.

* Under conditions of high temperature and humidity deterioration of the taping and packaging may be accelerated.

Please carefully control storage conditions and use the product within 6 months of receipt.

Soldering Conditions

■ Reflow soldering conditions



● Pb free solder recommended temperature profile

Type	Preheat		Soldering		Peak Temperature		Time of Reflow
	T1 [°C]	t1 [s]	T2 [°C]	t2 [s]	T3	T3 Limit	
□F	150 to 180	60 to 120	230 °C	40 max.	250 °C, 10 s	260 °C, 10 s	2 times max.
□E	150 to 180	60 to 120	230 °C	40 max.	250 °C, 10 s	260 °C, 10 s	2 times max.

■ Flow soldering conditions

Preheat: 130 to 150 °C, 60 to 180 s, Soldering: 260 °C, 5 s max.

■ Notes

- Solderability may be reduced due to the conditions of high temperature and high humidity which causes the oxidation of tin-plated terminals. Even if storage conditions are within specified limits, solderability may be reduced with the passage of time. Therefore, please control the storage conditions and try to use the product within 6 months of receipt.
- In case the product has been stored for a period longer than 6 months, use the product only after confirmation of its solderability.

Safety Precautions (Common precautions for Chip Inductors)

- When using our products, no matter what sort of equipment they might be used for, be sure to make a written agreement on the specifications with us in advance. The design and specifications in this catalog are subject to change without prior notice.
- Do not use the products beyond the specifications described in this catalog.
- This catalog explains the quality and performance of the products as individual components. Before use, check and evaluate their operations when installed in your products.
- Install the following systems for a failsafe design to ensure safety if these products are to be used in equipment where a defect in these products may cause the loss of human life or other significant damage, such as damage to vehicles (automobile, train, vessel), traffic lights, medical equipment, aerospace equipment, electric heating appliances, combustion/gas equipment, rotating equipment, and disaster/crime prevention equipment.
- * Systems equipped with a protection circuit and a protection device
- * Systems equipped with a redundant circuit or other system to prevent an unsafe status in the event of a single fault

Precautions for use

1. Operation range and environments

- ① These products are designed and manufactured for general and standard use in general electronic equipment (e.g. AV equipment, home electric appliances, office equipment, information and communication equipment)
- ② These products are not intended for use in the following special conditions. Before using the products, carefully check the effects on their quality and performance, and determine whether or not they can be used.
 - In liquid, such as water, oil, chemicals, or organic solvent
 - In direct sunlight, outdoors, or in dust
 - In salty air or air with a high concentration of corrosive gas, such as Cl₂, H₂S, NH₃, SO₂, or NO₂
 - In an environment where these products cause dew condensation

2. Handling

- ① Do not bring magnets or magnetized materials close to the product. The influence of their magnetic field can change the inductance value.
- ② Do not apply strong mechanical shocks by either dropping or collision with other parts.
Excessive shock can damage the part.

3. Land pattern design

- ① Please refer to the recommended land pattern for each type shown on the datasheet.
- ② Avoid placing the chip inductor on any metal pattern except the recommended land pattern because a drop of Q and mutual conductance may occur.
- ③ In case of flow soldering, venting of soldering flux gases should be made for high density assemblies to get a good solder connection.
- ④ In case of reflow soldering, consider the layout because taller components close to chip inductor tend to block thermal conduction.

4. Mounting

- ① In general, magnetic and electric characteristics of ferrite cores can be changed by applying excessively strong force. Placement force should not exceed 20 N.
- ② Do not bend or twist the PWB after mounting the part.

5. Cleaning

- ① Do not use acid or alkali agents. Some cleaning solvents may damage the part.
Confirm by testing the reliability in advance of mass production.
- ② If Ultrasonic cleaning is used, please confirm the reliability in advance.
It is possible that combined resonance of component and PWB and cavitation can cause an abnormal vibration mode to exist causing damage.

6. Caution about applying excessive current

The rated current is defined as the smaller value of either the current value when the inductance drops 10 % down from the initial point or the current value when the average temperature of coil inside rises 20 °C up from the initial point. Do not operate product over the specific max. current.

<Package markings>

Package markings include the product number, quantity, and country of origin.
In principle, the country of origin should be indicated in English.