

Tab terminals for lithium batteries

Panasonic has a variety of tab terminal shapes to meet your request.

Please note that it will be a customized solution if you need another tab terminal which is not shown on the website.

Lithium primary batteries : <https://industrial.panasonic.com/ww/products/batteries/primary-batteries/lithium-batteries?list=1>

Coin-type lithium rechargeable batteries : https://industrial.panasonic.com/ww/products/batteries/secondary-batteries/coin_rechargeable_lithium?list=1



F types

You can find detailed specifications on the web.

Please note that it will be a customized solution if you need another tab terminal which is not shown on the website.

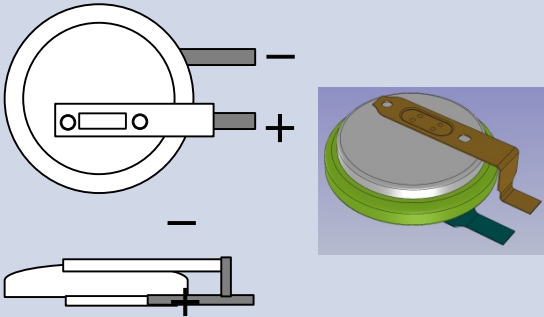
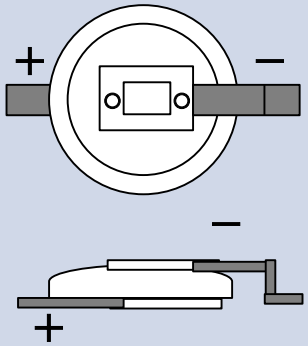
Tab type	Same direction for positive and negative terminal	Opposite direction for positive and negative terminal
Tab design		
Availability	<p>BR1220, BR1225, BR2032 BR1225A, BR2450A CR1220, CR2032 CR2032B, CR2050B2, CR2450A ML421, ML614, ML621, ML920 ML1220, ML1220T, MS614 VL621, VL1220, CTL1616F</p>	<p>BR1632, BR2032, BR2330, BR3032 BR1632A, BR2330A, BR2477A CR1620, CR1632, CR2032, CR2330 CR2354, CR2477, CR3032 ML1220 VL2020, VL2330, VL3032</p>

G types

You can find detailed specifications on the web.

Please note that it will be a customized solution if you need another tab terminal which is not shown on the website.

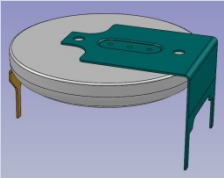
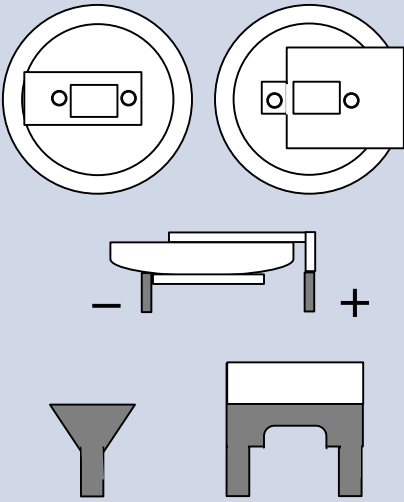
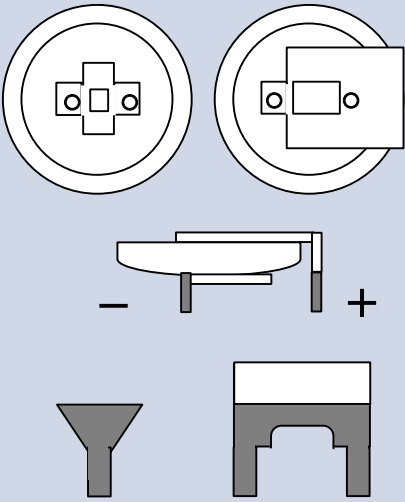
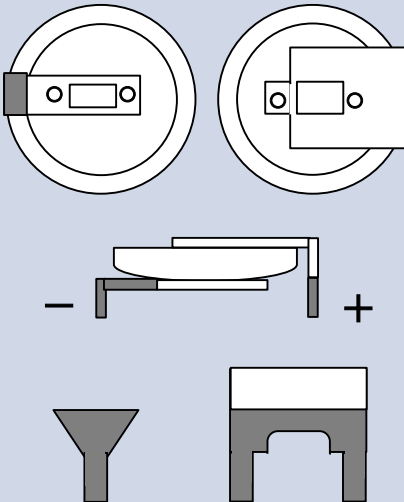
Tab type	Normal negative terminal position	Inner negative terminal position	Outer negative terminal position
<p>Tab design</p> 			
<p>Availability</p>	<p>BR2032, BR2325 BR1632A CR1632, CR2032</p>	<p>BR2330 BR2450A CR2330, CR2354, CR2450 CR2450A VL3032</p>	<p>BR2477A CR2477</p>

H types

You can find detailed specifications on the web.

Please note that it will be a customized solution if you need another tab terminal which is not shown on the website.

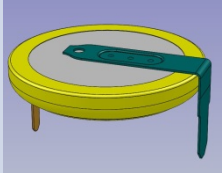
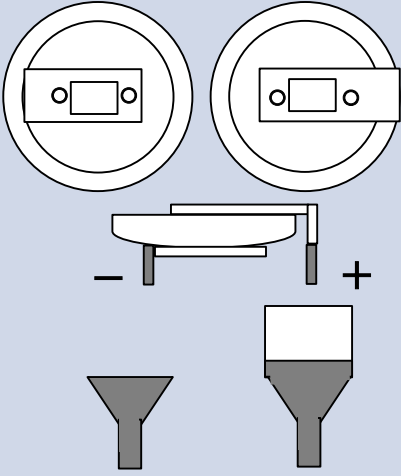
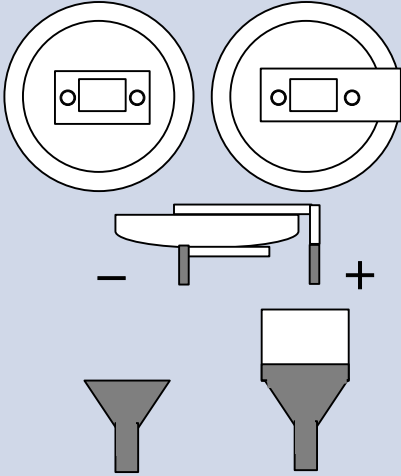
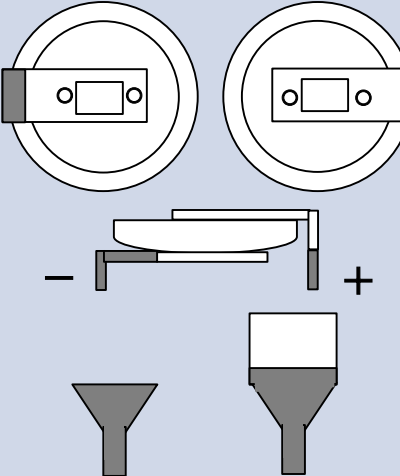
Tab type	Normal negative terminal position	Inner negative terminal position	Outer negative terminal position
<p>Tab design</p> 			
<p>Availability</p>	<p>BR1632, BR2325, BR2330 BR1632A, BR2330A CR1025, CR1632 CR2050A</p>	<p>BR1220, BR1225 BR1225A, BR2450A BR2477A CR1220, CR2354, CR2450 CR2477 ML1220 VL1220, VL2330</p>	<p>BR2032 CR2025, CR2032 CR2032A, CR2050B2 ML2020 VL2020</p>

V types

You can find detailed specifications on the web.

Please note that it will be a customized solution if you need another tab terminal which is not shown on the website.

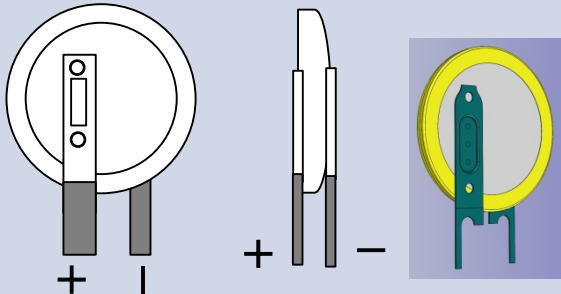
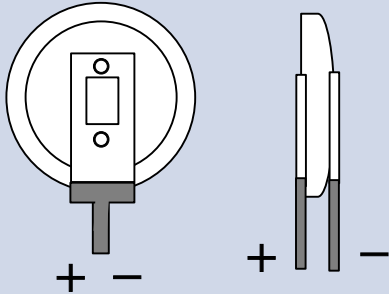
Tab type	Different position for positive and negative terminal	Same position for positive and negative terminal
Tab design		
Availability	BR1220 , BR1225 , BR1632 BR2325 , BR3032 BR1225A , BR1632A , BR2330A , BR2477A CR1220 , CR1632 CR2032 , CR2354 , CR2450 , CR2477 CR3032 ML2020 VL1220 , VL2020 , VL2330 , VL3032	ML1220

W types

You can find detailed specifications on the web.

Please note that it will be a customized solution if you need another tab terminal which is not shown on the website.

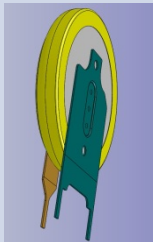
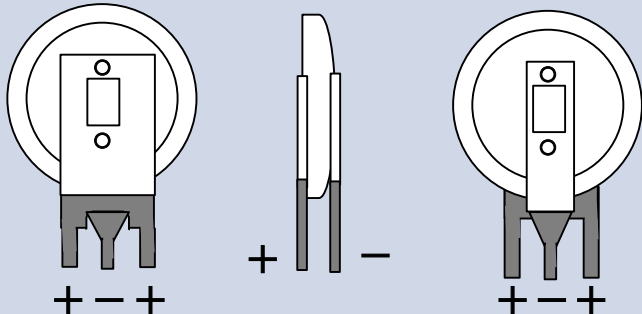
Tab type	Through hole type
<p data-bbox="227 611 394 645">Tab design</p> 	
<p data-bbox="227 1039 394 1073">Availability</p>	<p data-bbox="546 953 1070 1159">BR2032, BR2330 BR2330A CR2032, CR2330, CR2450, CR2477 ML2020 VL2330</p>

Lead wire type

You can find detailed specifications on the web.

Please note that it will be a customized solution if you need another tab terminal which is not shown on the website.

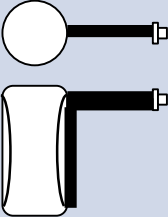
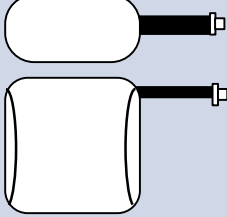
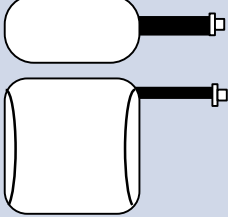
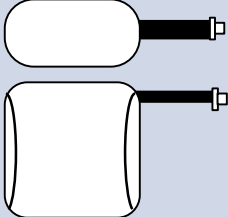
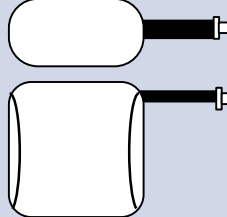
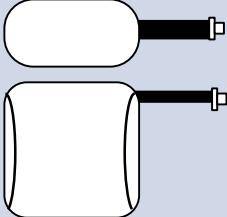
Tab type	Single cylindrical battery	Cylindrical batteries (2cells in parallel)	Cylindrical batteries (3cells in parallel)
Tab design			
Availability	BR-1/2AA CR-AGZ , CR-AG , CR-2/3AZ , CR2Z , CR2U , CR-AAU	CR-AGZ , CR-AG , CR-2/3AZ , CR2Z , CR2U , CR-AAU	CR-AGZ , CR-AG , CR-2/3AZ , CR2Z , CR2U , CR-AAU
Tab type	Cylindrical batteries (4cells in parallel)	Cylindrical batteries (5cells in parallel)	Cylindrical batteries (6cells in parallel)
Tab design			
Availability	CR-AGZ , CR-AG , CR-2/3AZ , CR-AAU	CR-AGZ , CR-AG , CR-2/3AZ , CR-AAU	CR-AGZ , CR-AG , CR-2/3AZ , CR-AAU

Lead wire type

You can find detailed specifications on the web.

Please note that it will be a customized solution if you need another tab terminal which is not shown on the website.

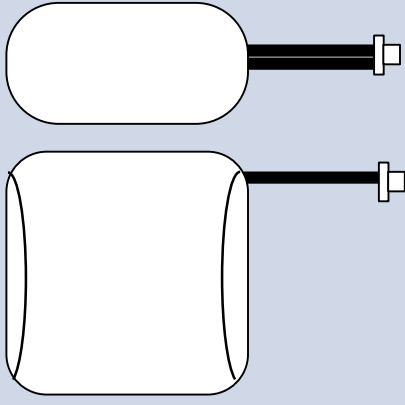
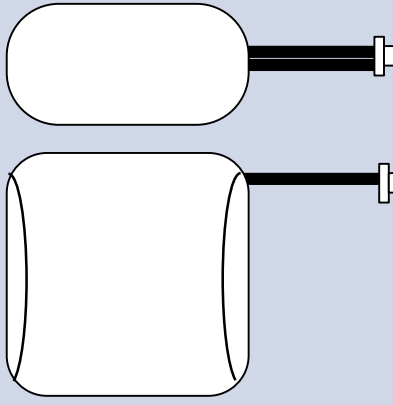
Tab type	Cylindrical batteries (2cells in series)	Cylindrical batteries (3cells in series)
Tab design		
Availability	CR-AGZ , CR-AG , CR-2/3AZ , CR2Z , CR2U , CR-AAU	CR123A , CR-AGZ , CR-AG , CR-2/3AZ , CR2Z , CR2U , CR-AAU , CR-AAK

Tab type for cylindrical batteries

You can find detailed specifications on the web.

Please note that it will be a customized solution if you need another tab terminal which is not shown on the website.

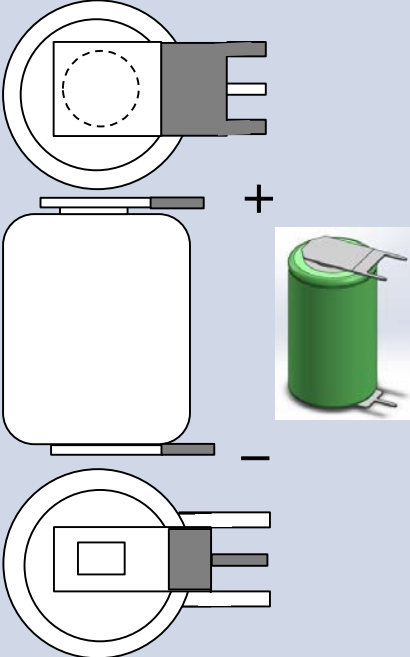
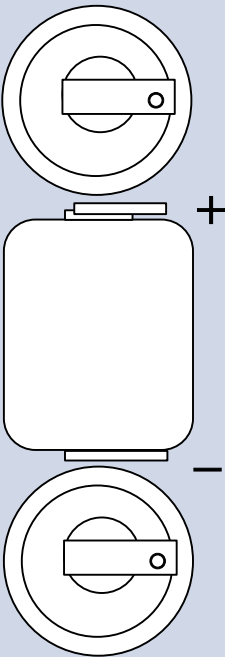
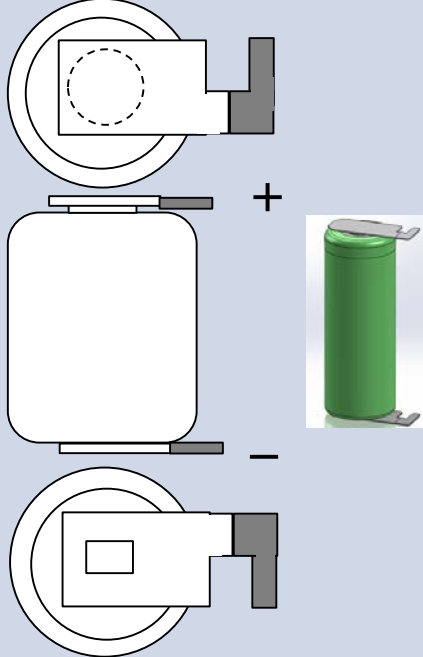
Tab type	Through hole type	Lead wire connect type	Hook type
<p>Tab design</p>			
<p>Availability</p>	<p>BR-1/2AA, BR-2/3A BR-2/3AG, BR-A, BR-AG CR-AGZ, CR-AG, CR-2/3AZ CR2Z, CR-AAU</p>	<p>BR-C</p>	<p>CR-AG, CR-2/3AZ</p>