

THIRD ANGLE PROJECTION

ITEM CODE	RATED VOLTAGE	CAP. (μ F)	DIMENSIONS			
			*L	*T	*H	*d
ECQE2103()F3	250VDC	0.01	10.3	4.3	7.4	0.6
# 2123()F3	#	0.012	#	4.4	7.5	#
# 2153()F3	#	0.015	#	#	#	#
# 2183()F3	#	0.018	#	#	#	#
# 2223()F3	#	0.022	#	#	#	#
# 2273()F3	#	0.027	#	#	#	#
# 2333()F3	#	0.033	#	4.5	#	#
# 2393()F3	#	0.039	#	#	#	#
# 2473()F3	#	0.047	#	#	#	#
# 2563()F3	#	0.056	#	4.8	7.9	#
# 2683()F3	#	0.068	#	4.5	7.5	#
# 2823()F3	#	0.082	#	4.9	8.0	#
# 2104()F3	#	0.1	#	5.8	8.4	#
# 2124()F3	#	0.12	#	6.0	9.0	#
# 2154()F3	#	0.15	#	#	10.8	#
# 2184()F3	#	0.18	12.0	5.0	10.3	#
# 2224()F3	#	0.22	#	5.5	10.5	#
# 2274()F3	#	0.27	#	6.0	11.5	#

TOL. SYMBOL (J or K)

ALTERATION		
ISSUE	DESCRIPTION	DATE
△	Overall rewriting	Nov. 7 1998
△	Modification	Jun. 20 2002
△	Company name changed	Oct. 1 2004
△	Company name changed	Apr. 1 2005

SPECIFICATIONS No.
TE72028Y

ITEM CODE NUMBER STRUCTURE

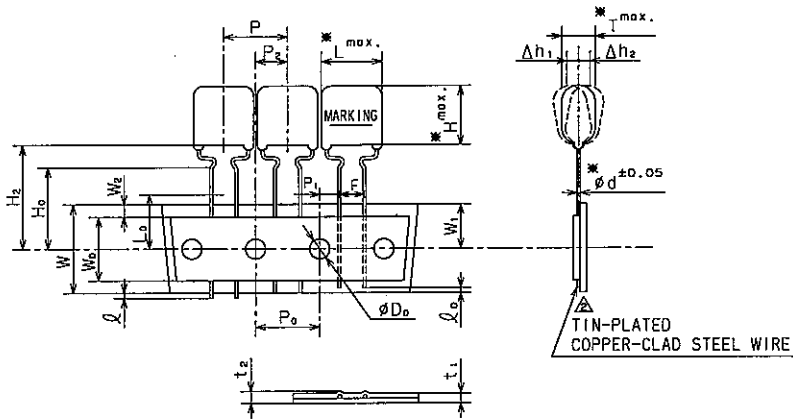
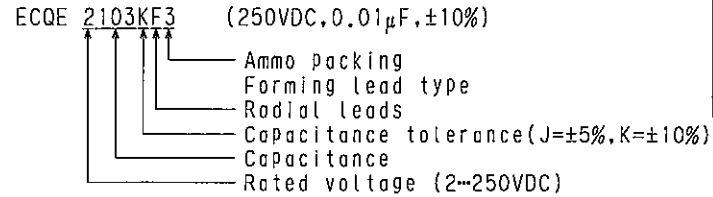

SYMBOL	ITEM	DIMENSION	REMARKS
P	Pitch of component	12.7 \pm 1.0	Tilt of component and curvature of leads shall be included.
P _p	Feed hole pitch	12.7 \pm 0.2	
P _f	Feed hole center to lead	3.85 \pm 0.5	
P ₂	Hole center to comp. center	6.35 \pm 1.3	Tilt of component due to curvature of leads shall be included.
F	Lead-to-lead distance	5.0 \pm 0.8	
Δh _{1,2}	Component alignment	0-2.0	Tilt of component due to curvature of leads shall be included.
W	Paper backing width	18.0 \pm 0.5	
W ₀	Adhesive tape width	9.5min.	The hold down tape shall not protrude beyond the carrier tape.
W ₁	Hole position	9.0 \pm 0.5	
W ₂	Hold-down tape position	0-3.0	
H ₂	Component height	22.0 \pm 0.75	
H ₀	Lead-wire clinch height	16.0 \pm 0.5	
f	Lead-wire protrusion	0max.	
f ₀	Lead-wire depression	7.0max.	
φD ₀	Feed hole diameter	4.0 \pm 0.2	
t ₁	Total tape thickness	0.7 \pm 0.2	Total thickness including the hold down tape.
t ₂	Total thickness	1.5max.	
L ₀	Length of snipped lead	11.0max.	

Reference

DESIGN	E. Takeda
CHECKED	M. Nishikori
APPROVAL	M. Nagaoaka
ESTABLISHMENT	Apr. 27, 1987
TYPE NAME	ECQE2***()F3
NAME	Metallized Polyester Film Capacitor
DRAWING NAME	PRODUCT DRAWING
DRAWING No.	CT-H-C013 (1/2)

CONSTRUCTION

The capacitor is of non-inductive construction, wound with metallized polyester film dielectric.

The capacitor is enclosed in non-combustible epoxy resin and has two leads.

MARKING

Marking comprises capacitance, capacitance tolerance, rated voltage and date code.

PROPERTIES

Capacitance : See table at 1kHz
 Capacitance tolerance : \pm 5%(J), \pm 10%(K) at 1kHz
 Rated voltage : 250VDC
 Withstand voltage : 250VDC \times 150% for 60s
 Insulation resistance : \geq 9000M Ω at 100VDC, 20 $^{\circ}$ C for 60s
 Dissipation factor : \leq 1.0% at 1kHz, 20 $^{\circ}$ C
 Category temperature range : From -40 $^{\circ}$ C to +85 $^{\circ}$ C
 (including temperature rise on unit surface)

MARKING EXAMPLE

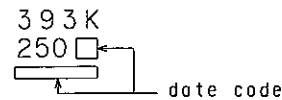

DO NOT SCALE DRAWING REVISIONS INDICATED BY Δ ALL DIMENSIONS ARE IN MILLIMETERS

Panasonic Electronic Circuit Capacitor Business Unit,
Panasonic Electronic Devices Co., Ltd.

- Note 1. No more than 3 consecutive missing is permitted.
 Note 2. A tape conjunction and a tape discrepancy specify as follows.

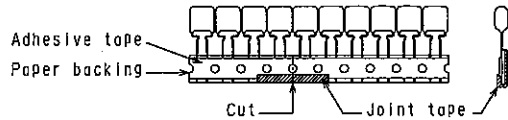

A tape sliding shall not exceed in an allowance of "P₀" dimension.
 A joint tape put on the back side of paper backing, and turn up the lower part to the front.

- Note 3. Marking on components may not be the same side.
 Note 4. The tape adhesion is more than 3.92N(400gf)/25mm.
 Note 5. A tape trailer having at least 3 feed holes is required at the end of the tape.
 Note 6. 1)The P₁ and P₂ dimension shall be measured as shown in the figure after the adhesive tape placing upward.
 (measuring from the center of sprocket hole to the right.)
 2)The P₂ dimension shall be measured between center of a vertical projection plane for tape plane and center of sprocket hole.

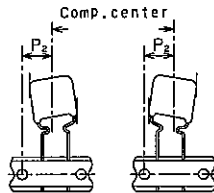

- Note 7. The lead crimping shape shows as follows.

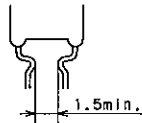

Packing specification

1. Case size
Ammo pack

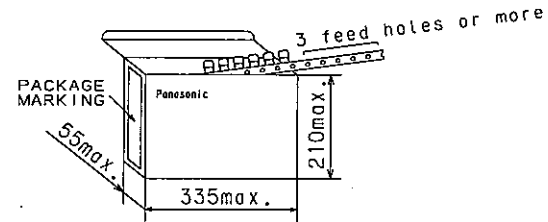

2. Packing quantity

Capacitance range	Packing quantity
0.01~0.082 μ F	1000
0.1~0.27 μ F	500

3. Handling notes

- 1)One package must be packed one product only.
- 2)The storage must be stacked 5 boxes or less (surface printed placing upward). (For prevention from displacement of capacitors and damage of lead crimping.)
- 3)The packing box must be handled with care and never thrown out.

Reference

TYPE NAME	ECQE2***()F3
DRAWING No.	CT-H-C013 (2/2)

Panasonic Electronic Circuit Capacitor Business Unit,
 Panasonic Electronic Devices Co.,Ltd.

THIRD ANGLE PROJECTION

ITEM CODE	RATED VOLTAGE	CAP. (μ F)	DIMENSIONS				
			*L	*T	*H	*d	*H ₁
ECQE2334()F3	250VDC	0.33	12.0	6.5	12.0	0.6	33.5

TOL. SYMBOL (J or K)

ALTERATION		
ISSUE	DESCRIPTION	DATE
△	Overall rewriting	Nov. 7 1998
△	Modification	Jun. 20 2002
△	Company name changed	Oct. 1 2004
△	Company name changed	Apr. 1 2005

SPECIFICATIONS No.
TE8Y160H

ITEM CODE NUMBER STRUCTURE

ECQE 2334KF3 (250VDC, 0.33 μ F, \pm 10%)

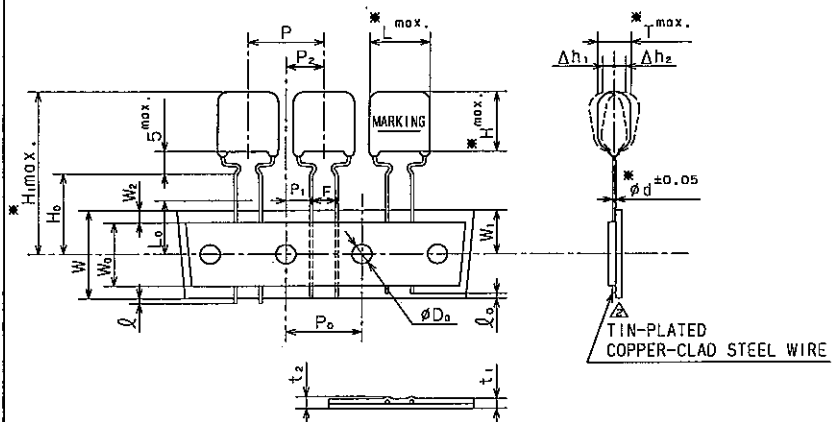
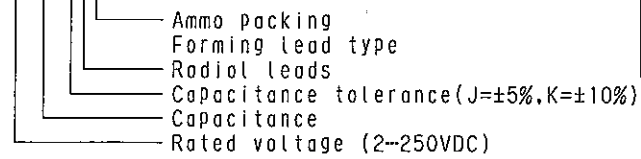

SYMBOL	ITEM	DIMENSION	REMARKS
P	Pitch of component	15.0 \pm 1.0	Tilt of component and curvature of leads shall be included.
P ₀	Feed hole pitch	15.0 \pm 0.2	
P ₁	Feed hole center to lead	5.0 \pm 0.5	
P ₂	Hole center to comp. center	7.5 \pm 1.3	Tilt of component due to curvature of leads shall be included.
F	Lead-to-lead distance	5.0 \pm 0.8	
Δh _{1,2}	Component alignment	0-2.0	Tilt of component due to curvature of leads shall be included.
W	Paper backing width	18.0 \pm 0.5	
W ₀	Adhesive tape width	9.5min.	The hold down tape shall not protrude beyond the carrier tape.
W ₁	Hole position	9.0 \pm 0.5	
W ₂	Hold-down tape position	0-3.0	
H ₀	Lead-wire clinch height	16.0 \pm 0.5	
t	Lead-wire protrusion	0max.	
t ₀	Lead-wire depression	7.0max.	
φD ₀	Feed hole diameter	4.0 \pm 0.2	
t ₁	Total tape thickness	0.7 \pm 0.2	Total thickness including the hold down tape.
t ₂	Total thickness	1.5max.	
L ₀	Length of snapped lead	11.0max.	

Reference

CONSTRUCTION

The capacitor is of non-inductive construction, wound with metallized polyester film dielectric.
The capacitor is enclosed in non-combustible epoxy resin and has two leads.

MARKING

Marking comprises capacitance, capacitance tolerance, rated voltage and date code.

PROPERTIES

Capacitance	:See table	at 1kHz
Capacitance tolerance	:±5%(J), ±10%(K)	at 1kHz
Rated voltage	:250VDC	
Withstand voltage	:250VDCx150%	for 60s
Insulation resistance	:≥9000MΩ	at 100VDC, 20°C for 60s
Dissipation factor	:≤1.0%	at 1kHz, 20°C
Category temperature range	:From -40°C to +85°C	
(including temperature rise on unit surface)		

MARKING EXAMPLE

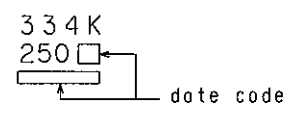

DESIGN	E. Tabata
CHECKED	M. Nishikori
APPROVAL	M. Nagata
ESTABLISHMENT	Jan. 5, 1994
TYPE NAME	ECQE2334()F3
NAME	Metallized Polyester Film Capacitor
DRAWING NAME	PRODUCT DRAWING
DRAWING No.	CT-H-3B4E (1/2)

Panasonic Electronic Circuit Capacitor Business Unit,
Panasonic Electronic Devices Co., Ltd.

Note 1. No more than 3 consecutive missing is permitted.
 Note 2. A tape conjunction and a tape discrepancy specify as follows.

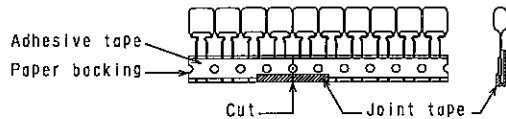

A tape sliding shall not exceed in an allowance of "P₀" dimension.
 A joint tape put on the back side of paper backing, and turn up the lower part to the front.

Note 3. Marking on components may not be the same side.
 Note 4. The tape adhesion is more than 3.92N(400gf)/25mm.
 Note 5. A tape trailer having at least 3 feed holes is required at the end of the tape.

Packing specification

1. Case size
Ammo pack

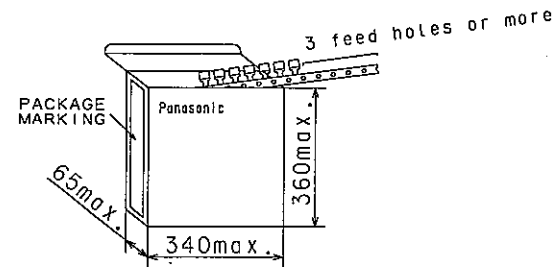

2. Packing quantity

Capacitance range	Packing quantity
0.33 μ F	1000

3. Handling notes

- 1) One package must be packed one product only.
- 2) The storage must be stacked 5 boxes or less (surface printed placing upward). (For prevention from displacement of capacitors and damage of lead crimping.)
- 3) The packing box must be handled with care and never thrown out.

Reference

TYPE NAME	ECQE2334()F3
DRAWING No.	CT-H-3B4E (2/2)

Panasonic Electronic Circuit Capacitor Business Unit,
 Panasonic Electronic Devices Co., Ltd.

THIRD ANGLE PROJECTION

ITEM CODE	RATED VOLTAGE	CAP. (μ F)	DIMENSIONS				
			* L	* T	* H	* d	* H ₁
ECQE2394()F3	250VDC	0.39	18.5	4.9	12.0	0.6	33.5
# 2474()F3	#	0.47	#	5.3	12.5	#	34.0
# 2564()F3	#	0.56	#	5.5	13.0	#	34.5
# 2684()F3	#	0.68	#	6.0	13.5	0.8	35.0
# 2824()F3	#	0.82	#	6.5	14.5	#	36.0
# 2105()F3	#	1.0	#	7.4	15.0	#	36.5
# 2125()F3	#	1.2	#	8.0	15.9	#	37.4
# 2155()F3	#	1.5	#	9.0	16.8	#	38.3

ALTERATION		
ISSUE	DESCRIPTION	DATE
△	Overall rewriting	Nov. 7 1998
△	Modification	Jun. 20 2002
△	Company name changed	Oct. 1 2004
△	Company name changed	Apr. 1 2005

SPECIFICATIONS No.
TE88119H

ITEM CODE NUMBER STRUCTURE

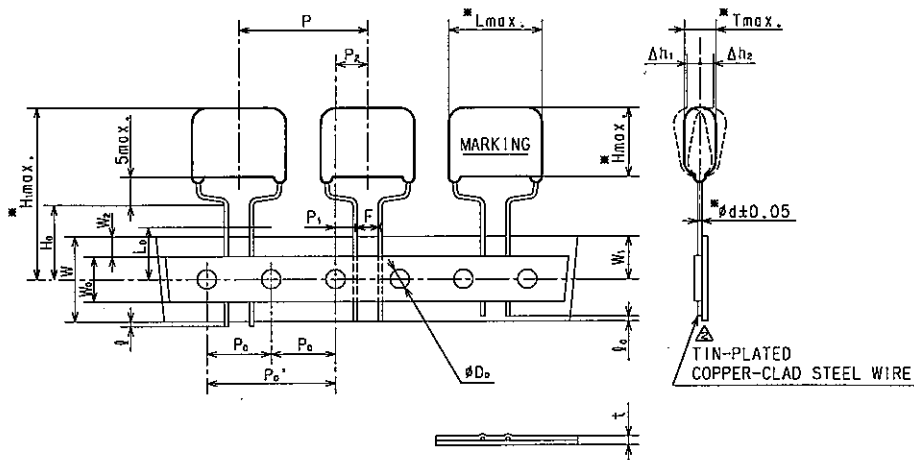
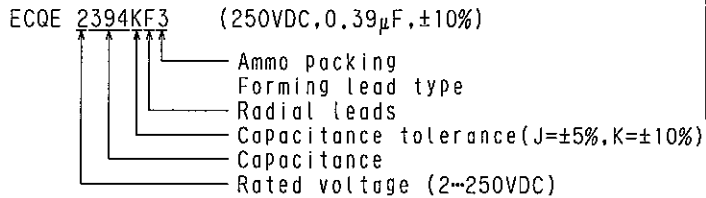

SYMBOL	ITEM	DIMENSION	REMARKS
P	Pitch of component	25.4 \pm 1.0	Tilt of component and curvature of leads shall be included.
P ₀	Feed hole pitch	12.7 \pm 0.2	
P ₀ '	#	25.4 \pm 0.2	
P ₁	Feed hole center to lead	3.85 \pm 0.5	
P ₂	Hole center to comp. center	6.35 \pm 1.3	Tilt of component due to curvature of leads shall be included.
F	Lead-to-lead distance	5.0 \pm 0.5	
Δh _{1,2}	Component alignment	0-2.0	Tilt of component due to curvature of leads shall be included.
W	Paper backing width	18.0 \pm 0.5	
W ₀	Adhesive tape width	12.5min.	The hold down tape shall not protrude beyond the carrier tape.
W ₁	Hole position	9.0 \pm 0.5	
W ₂	Hold-down tape position	0-3.0	
H _c	Lead-wire clinch height	16.0 \pm 0.5	
l	Lead-wire protrusion	0max.	
l ₀	Lead-wire depression	7.0max.	
φD ₀	Feed hole diameter	4.0 \pm 0.2	
t	Total tape thickness	0.7 \pm 0.2	Total thickness including the hold down tape.
L _c	Length of snipped lead	11.0max.	

CONSTRUCTION

The capacitor is of non-inductive construction, wound with metallized polyester film dielectric.
The capacitor is enclosed in non-combustible epoxy resin and has two leads.

MARKING

Marking comprises capacitance, capacitance tolerance, rated voltage, manufacturer's trademark and date code.

PROPERTIES

Capacitance : See table at 1kHz
 Capacitance tolerance : \pm 15%(J), \pm 10%(K) at 1kHz
 Rated voltage : 250VDC
 Withstand voltage : 250VDC \times 150% for 60s
 Insulation resistance : \geq 3000M Ω \cdot μ F at 100VDC, 20°C for 60s
 Dissipation factor : \leq 1.0% at 1kHz, 20°C
 Category temperature range : From -40°C to +85°C
 (including temperature rise on unit surface)

MARKING EXAMPLE

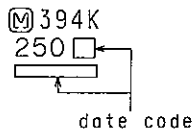

Reference

DESIGN	E. Tabada
CHECKED	M. Nishikori
APPROVAL	M. Magawa
ESTABLISHMENT	Jan. 5, 1994
TYPE NAME	ECQE2***()F3
NAME	Metallized Polyester Film Capacitor
DRAWING NAME	PRODUCT DRAWING
DRAWING No.	CT-H-3B6E (1/2)

Panasonic Electronic Circuit Capacitor Business Unit,
Panasonic Electronic Devices Co., Ltd.

Note 1. No more than 2 consecutive missing is permitted.
 Note 2. A tape conjunction and a tape discrepancy specify as follows.

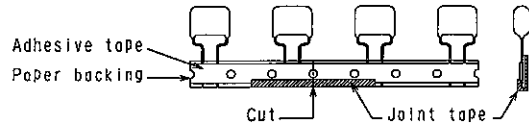

A tape sliding shall not exceed in an allowance of "Po" dimension.
 A joint tape put on the back side of paper backing, and turn up the lower part to the front.

Note 3. Marking on components may not be the same side.
 Note 4. The tape adhesion is more than 3.92N(400gf)/25mm.
 Note 5. A tape trailer having at least 3 feed holes is required at the end of the tape.

Packing specification

1. Case size
 Ammo pack

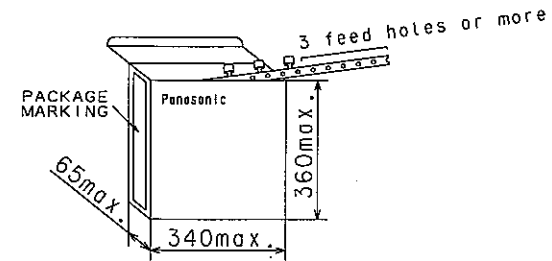

2. Packing quantity

Capacitance range	Packing quantity
0.39~1.2 μ F	500
1.5 μ F	400

3. Handling notes

- 1) One package must be packed one product only.
- 2) The storage must be stacked 5 boxes or less (surface printed placing upward). (For prevention from displacement of capacitors and damage of lead crimping.)
- 3) The packing box must be handled with care and never thrown out.

Reference

TYPE NAME	ECQE2***()F3
DRAWING No.	CT-H-3B6E (2/2)

Panasonic Electronic Circuit Capacitor Business Unit,
 Panasonic Electronic Devices Co., Ltd.